



MERCHANDISE PRO

Catalogue

CHR

2023

SOMMAIRE / CONTENTS

REFRIGERATION / REFRIGERATED PRODUCTS	
ARMOIRES RÉFRIGÉRÉES / UPRIGHT COUNTERS ARMOIRES À BOISSON / VERTICAL SHOWCASE ARRIÈRES BAR / BACK BAR COUNTERS TABLES À PIZZA / REFRIGERATED PIZZA TABLES TABLES À PIZZA AVEC GRANIT NOIR / REFRIGERATED PIZZA TABLES WITH BLACK GRANITE VITRINES RÉFRIGÉRÉES / REFRIGERATED DISPLAY MEUBLES RÉFRIGÉRÉS 700 / REFRIGERATED COUNTERS 700 MEUBLES RÉFRIGÉRÉS 700 (TIROIRS) / REFRIGERATED COUNTERS 700 (DRAWERS) MEUBLES RÉFRIGÉRÉS 600 / REFRIGERATED COUNTERS 600 MEUBLES RÉFRIGÉRÉS 800 / REFRIGERATED COUNTERS 800 SALADETTES SNACK LINE / SNACK LINE SALAD COUNTERS BAIN-MARIE SNACK LINE / SNACK LINE WATER BATH CAISSES BOISÉS SNACK LINE / SNACK LINE WOODED CHECKOUT TABLES SALADETTES / SALAD COUNTERS CELLULE DE REFROIDISSEMENT / COOLING CELL	01 07 09 11 15 17 19 22 24 27 30 33 36 38 51
MATÉRIELS INOX / STAINLESS STEEL PRODUCTS	
TABLES EN INOX / STAINLESS STEEL TABLES	
TIROIRS / DRAWERS	53
TABLES DE BOUCHERIE / BUTCHER TABLES	56
ÉTAGÈRES DU CHEF / CHEF SHELF	57
RAMPES CHAUFFANTES / HEATED GANTRY	58
PLACARDS EN INOX / STAINLESS STEEL CABINET	59
PLACARDS MURAUX EN INOX / STAINLESS STEEL WALL CABINET	60
PLONGES EN INOX / STAINLESS STEEL SINK	64
LAVE MAINS INOX / STAINLESS STEEL HANDWASH SINK	65
ÉTAGÈRE MURALES / STAINLESS STEEL WALL SHELVES	69
CHARIOTS / STAINLESS STEEL TROLLEY	70
POUBELLES / TRASH BIN	72
RAYONNAGES INOX / STAINLESS STEEL SHELVING	73
ÉCHELLES INOX / STAINLESS STEEL LADDER	74
SÉPARATEUR DE GRAISSE / STAINLESS STEEL SEPERATOR	75
	75

SOMMAIRE / CONTENTS

CUISSON & SNACK / COOKING & SNACK PRODUCTS

GAUFRIER / WAFFEL MAKER

TOASTER / TOASTER

PLAQUE À SNACKER / GRIDDLE PLATE

HACHOIR À VIANDE / MEAT MINCER

COUPES- LÉGUME / VEGETABLE CUTTER

MARMITE À SOUPE/ SOUP POT

BAIN MARIE / WATER BATH

FOURNEAUX À GAZ / GAS COOKER

RECHAUD WOK / CHINESE WOK

RECHAUD À GAZ / GAS STOVE

CONDITIONS DE VENTES / CONDITIONS OF SALES

76

77

77

78

78

79

79

81

83

85

86



ARMOIRES RÉFRIGÉRÉES

UPRIGHT COUNTERS



THL1410TN/BT



Code / Article	POSITIVE		NEGATIVE	
	THL1410TN / GN 2/1	THL1180TN	THL1410BT / GN 2/1	THL1180BT
Ext. L x P x H (mm) Int. L x P x H	1480 x 830 x 2010	1480 x 730 x 2010	1480 x 830 x 2010	1480 x 730 x 2010
(mm) Capacité / Capacity (L)	1360 x 700 x 1400	1360 x 600 x 1400	1360 x 700 x 1400	1360 x 600 x 1400
Température / Temperature	1333 1001	1145 800	1333 1001	1145 800
Énergétique / Energy Evaporation	-2 + 8 (°C)	-2 + 8 (°C)	-18 - 22 (°C)	-18 - 22 (°C)
Consommation d'énergie / Power	E	E	D	E
Tension / Voltage	Ventilée / Fan	Ventilée / Fan	Ventilée / Fan	Ventilée / Fan
	5,05 (kW/24h)	4,09 (kW/24h)	11,94 (kW/24h)	12,05 (kW/24h)
	230 / 50 (V/Hz)	230 / 50 (V/Hz)	230 / 50 (V/Hz)	230 / 50 (V/Hz)
Prix / Price	3099 €	2999 €	3199 €	3099 €

- Gaz écologique R290 / Green Gas R290
- Intérieur et extérieur en acier inoxydable / Interior exterior stainless steel
- Thermostat à affichage digital, Dixell ou Eliwell / Digital controller Eliwell ou Dixell
- Isolation sans CFC épaisseur 60mm / Insulation thickness 60mm
- Fermeture de porte automatique / Self closing door
- Classe climatique / Climate class 4
- Dégivrage automatique / Automatic defrosting system
- Montée sur roues / With wheels
- Porte avec serrure / Door with lock
- 3 grilles par porte (sauf THPA800) / 3 shelves per door (Except THPA800)



Code / Article
Grille / Shelf - THL400/THL580/THL1180 (530x550x42mm)
Grille / Shelf – THL650/THL1410 (530x650xGN2/1)
Grille / Shelf – THPA800 (600x800)
Glissières (Paire) / Guide (Pair) - THL400/THL580/THL1180
Glissières (Paire) / Guide (Pair) – THL650 /THL1180
Glissières (Paire) / Guide (Pair) – THPA800

Veuillez nous consulter pour les tarifs



Code / Article
Roues lot de 4/ Wheels set
Pied / Feet / unité

Veuillez nous consulter pour les tarifs



Contrôle Digital
Digital Control



Éclairage
Light



Fermeture
automatique
Self closing



Serpentin en
cuivre
Copper Oil



Vérouillage
Locking



Roues ou Pieds
Wheels or Feet

ARMOIRES RÉFRIGÉRÉES

UPRIGHT COUNTERS



Code / Article	THL650TN / GN 2/1	THL580TN
Ext. L x P x H (mm)	740 x 830 x 2010	740 x 730 x 2010
Int. L x P x H (mm)	624 x 700 x 1400	624 x 600 x 1400
Capacité / Capacity (L)	610 456	525 373
Température / Temperature	-2 + 8 (°C)	-2 + 8 (°C)
Énergétique / Energy	C	D
Evaporation	Ventilée / Fan	Ventilée / Fan
Consommation d'énergie / Power	2,35 (kW/24h)	2,35 (kW/24h)
Tension / Voltage	230 / 50 (V/Hz)	230 / 50 (V/Hz)
Prix / Price	1699 €	1659 €

- Gaz écologique R290 / Green Gas R290
- Intérieur et extérieur en acier inoxydable (Paroi arrière galvanisée) / Interior exterior stainless steel (Galvanized rear wall)
- Compresseur Aspera, Secop ou Danfoss / Aspera, Secop ou Danfoss compressor
- Thermostat à affichage digital, Dixell ou Eliwell / Digital controller Eliwell ou Dixell
- Isolation sans CFC épaisseur 60mm / Insulation thickness 60mm
- Fermeture de porte automatique / Self closing door
- Classe climatique / Climate class 4
- Dégivrage automatique / Automatic defrosting system
- Montée sur roues / With wheels
- Porte avec serrure / Door with lock
- 3 grilles par porte (sauf THPA800) / 3 shelves per door (Except THPA800)

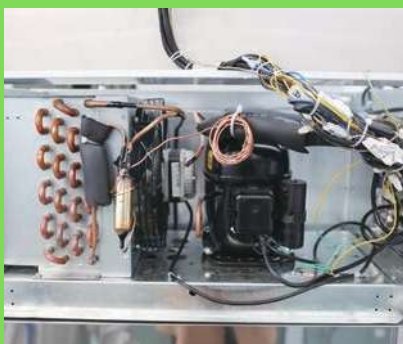

Compresseur de marques Brands compressor



Contrôle Digital Digital Control



Éclairage Light



Fermeture automatique Self closing



Serpentin en cuivre Copper Oil



Vérouillage Locking



Roues ou Pieds Wheels or Feet

ARMOIRES RÉFRIGÉRÉES

UPRIGHT COUNTERS



THL650BT



Code / Article	THL650BT / GN 2/1	THL580BT
Ext. L x P x H (mm) Int. L x P x H	740 x 830 x 2010	740 x 730 x 2010
(mm) Capacité / Capacity (L)	624 x 700 x 1400	624 x 600 x 1394
Température / Temperature	610 456	525 373
Énergétique / Energy Evaporation	-18 - 22 (°C)	-18 - 22 (°C)
Consommation d'énergie / Power	D	D
Tension / Voltage Prix / Price	Ventilée / Fan	Ventilée / Fan
	8,56 (kW/24h)	6,59 (kW/24h)
	230 / 50 (V/Hz)	230 / 50 (V/Hz)
	1899 €	1859 €

ARMOIRES RÉFRIGÉRÉES

UPRIGHT COUNTERS



Livré sans grilles avec 10 paires de glissières
No shelf and only 10 shelf supports

Code / Article	THPA800TN	THPA800BT
Ext. L x P x H (mm) Int. L x P x H	740 x 990 x 2010	740 x 990 x 2010
(mm) Capacité / Capacity (L)	624 x 845 x 1390	624 x 845 x 1390
Température / Temperature	733 630	733 630
Énergétique / Energy Evaporation	-2 +8 (°C)	-18 -22 (°C)
Consommation d'énergie / Power	E	D
Tension / Voltage Prix / Price	Ventilée / Fan	Ventilée / Fan
	3,74 (kW/24h)	8.1 (kW/24H)
	230 / 50 (V/Hz)	230 / 50 (V/Hz)
	2399 €	2599 €

ARMOIRES À BOISSON

VERTICAL SHOWCASE



THLC278AF/THLC318AF



THLC628M2AF/THLC828M2AF

Code / Article	THLC278AF	THLC318AF	THLC628M2AF	THLC828MAF
Ext. L x P x H (mm)	620 x 595 x 1855	620 x 595 x 2005	1080 x 595 x 2100	1220 x 668 x 2080
Capacité / Capacity (L)	278	318	600	810
Température / Temperature	+2/+8 °C	+2/+8 °C	+2/+8 °C	+2/+8 °C
Énergétique / Energy	D	D	D	E
Consommation d'énergie / Power	6,09 kWh/24h	6,13 kWh/24h	7,95 kWh/24h	11,66 kWh/24h
Tension / Voltage	230 / 50 (V/Hz)	230 / 50 (V/Hz)	230 / 50 (V/Hz)	230 / 50 (V/Hz)
Prix / Price	859 €	959 €	1499 €	1699 €



- Écran éclairé
- Boîtier extérieur en tôle d'acier laquée
- Porte vitrée isolante à fermeture automatique

- Avec porte en verre isolant à fermeture automatique (charnière de porte non réversible)
- Porte en verre isolant avec cadre noir
- Nettoyage particulièrement facile grâce aux coins et bords arrondis

- Système de refroidissement statique à circulation forcée

- Grilles de support réglables en hauteur par porte

- Serrure de porte et clé incluses

- Fluide frigorigène R290 respectueux de l'environnement
- Compresseur de marque
- Température stable et économie d'énergie

- Appareils avec 4 roulettes, 2 avec frein et 2 sans frein

- Thermostat numérique Dixell
- Température : -1°C/+10°C
- Classe climatique 4 (température ambiante 30°C et humidité ambiante 55%)

ARRIÈRES BAR

BACK BAR COUNTERS

- Gaz écologique R600A / Green Gas R600A
- Extérieur en carrosserie noir / Exterior in black body colour
- Intérieur en aluminium / Interior aluminium
- Refroidissement statique ventilateur Force air fan cooling
- Thermostat à affichage digital / Digital controller
- Porte vitrée isolante / Double glazed glass door
- Post libre, non encastrable / no build-in

- Fermeture automatique des portes / Self closing door
- Classe climatique 4 / Climate classe 4
- Éclairage intérieur LED / Interior light LED
- Fermeture à clé / Closing key
- 2 Grilles par porte / 2 shelves each door

Portes Coulissantes / With Sliding Door



TSC2E90BS

Code / Article	TSC2E90BS
L x T x H (mm)	900 x 525 x 900
Capacité / Capacity	190 (L)
Température / Temperature	+2 +8 (°C)
Puissance / Power	195 (W)
Tension / Voltage	230 / 50 (V/Hz)
Prix / Price	1099 €



TSC3E90BS

Code / Article	TSC3E90BS
L x T x H (mm)	1335 x 525 x 900
Capacité / Capacity	290 (L)
Température / Temperature	+2 +8 (°C)
Puissance / Power	295 (W)
Tension / Voltage	230 / 50 (V/Hz)
Prix / Price	1299 €

ARRIÈRES BAR

BACK BAR COUNTERS

Portes Battantes / With Handle Door



TSC1E90B

Code / Article	TSC1E90B
L x T x H (mm)	600 x 525 x 900
Capacité / Capacity	120 (L)
Température / Temperature	+2 +8 (°C)
Puissance / Power	172 (W)
Tension / Voltage	230 / 50 (V/Hz)
Prix / Price	759 €



TSC2E90B

Code / Article	TSC2E90B
L x T x H (mm)	900 x 525 x 900
Capacité / Capacity	190 (L)
Température / Temperature	+2 +8 (°C)
Puissance / Power	195 (W)
Tension / Voltage	230 / 50 (V/Hz)
Prix / Price	999 €



TSC3E90B

Code / Article	TSC3E90B
L x T x H (mm)	1335 x 525 x 900
Capacité / Capacity	290 (L)
Température / Temperature	+2 +8 (°C)
Puissance / Power	295 (W)
Tension / Voltage	230 / 50 (V/Hz)
Prix / Price	1199 €

TABLE À PIZZA

REFRIGERATED PIZZA TABLE

-Gaz écologique R290 / Green Gas R290 -Intérieur et extérieur en acier inoxydable (Paroi arrière galvanisée) / Interior exterior stainless steel (Galvanized rear wall) - Réfrigération ventilée / Ventilated cooling system - Thermostat à affichage digital, Dixell ou Eliwell / Digital controller Eliwell ou Dixell

-Isolation sans CFC épaisseur 60mm / Insulation thickness 60mm -Fermeture automatique des portes / Self closing door -Montée sur 4/6 roues (2/3 avec freins et 2/3 sans freins) / With 4/6 wheels (2/3 with brakes and 2/3 without brakes) - Joint de porte lavable et remplaçable / Washable and replaceable door seals -Plan de travail en granit / Granit work top -1 grille par porte (600x400) / 1 shelf per door (600x400)



Fermeture automatique
Self closing



Montée sur les roues
With wheels



Contrôle Digital
Digital Control



Compresseur de marques
Brands compressor



Joint remplaçable
Replaceable door seal



THPZ2600TN Vitrine (THV) en option



THPZ3600TN Vitrine (THV) en option

TABLE À PIZZA

REFRIGERATED PIZZA TABLE



Code / Article	THPZ2600TN	THPZ3600TN
Ext. L x P x H (mm)	1510 x 800 x 1000	2025 x 800 x 1000
Int. L x P x H (mm)	1052 x 630 x 589	1562 x 630 x 589
Capacité / Capacity (L)	390 307	580 458
Température / Temperature	-2 + 8 (°C)	-2 + 8 (°C)
Énergétique / Energy Class	B	C
Evaporation	Ventilée / Fan	Ventilée / Fan
Consommation d'énergie / Power	2,53 (kW/24h)	3,59 (kW/24h)
Tension / Voltage	230 / 50 (V/Hz)	230 / 50 (V/Hz)
Option	THV1500/330 -380	THV2000 / 330 -380
Prix / Price	2099 €	2499 €

TABLE À PIZZA

REFRIGERATED PIZZA TABLE



Code / Article	THV2520/380
Ext. L x P x H (mm)	2520 x 395 x 435
Int. L x P x H (mm)	2170 x 310 x 165
Température / Temperature	-2 +8 (°C)
Evaporation	Stat.
Puissance / Power	149W
Tension / Voltage	230 / 50 (V/Hz)
Prix / Price	1199€



Code / Article	THPZ4600TN
Ext. L x P x H (mm)	2525 x 800 x 1000
Int. L x P x H (mm)	1969 x 680 x 575
Capacité / Capacity (L)	770
Température / Temperature	-2 + 8 (°C)
Énergétique / Energy Class	C
Evaporation	Ventilée / Fan
Consommation d'énergie / Power	4,45 (kW/24h)
Tension / Voltage	230 / 50 (V/Hz)
Option	THV2520/380
Prix / Price	3399€

TABLE À PIZZA

REFRIGERATED PIZZA TABLE



THPZ1610TN

※7 Tiroirs non réfrigérés, dimensions 770x485x75mm
7 Drawers unrefrigerated, dimention 770x485x75mm



THPZ2610TN



Code / Article	THPZ1610TN	THPZ2610TN
Ext. L x P x H (mm)	1510 x 800 x 1000	2025 x 800 x 1000
Int. L x P x H (mm)	1052 x 630 x 589	1562 x 630 x 589
Capacité / Capacity (L)	390 (L) 145 (L)	580 (L) 307 (L)
Température / Temperature	-2 + 8 (°C)	-2 +8 (°C)
Énergétique / Energy Class	B	C
Evaporation	Ventilée / Fan	Ventilée / Fan
Consommation d'énergie / Power	1,53 (kW/24h)	2,53 (kW/24h)
Tension / Voltage	230 / 50 (V/Hz)	230 / 50 (V/Hz)
Option	THV1500/330 -380	THV2000 / 330 -380
Prix / Price	2399 €	2699 €

TABLE À PIZZA AVEC GRANIT NOIR

REFRIGERATED PIZZA TABLE WITH BLACK GRANITE

- Gaz écologique R290 / Green Gas R290 - Intérieur et extérieur en acier inoxydable (Paroi arrière galvanisée) / Interior exterior stainless steel (Galvanized rear wall) - Réfrigération ventilée / Ventilated cooling system - Thermostat à affichage digital, Dixell ou Eliwell / Digital controller Eliwell ou Dixell

- Isolation sans CFC épaisseur 60mm / Insulation thickness 60mm
 - Fermeture automatique des portes / Self closing door
 - Montée sur 6 roues (3 avec freins et 3 sans freins) / With 6 wheels (3 with brakes and 3 without brakes)
 - Joint de porte lavable et remplaçable / Washable and replaceable door seals
 - Plan de travail en granit noir / Black granit work top
 - 1 grille par porte (600x400) / 1 shelf per door (600x400)



Fermeture automatique
Self closing



Montée sur les roues
With wheels



Contrôle Digital
Digital Control



Compresseur de marques
Brands compressor



Joint remplaçable
Replaceable door seal



THPZ2600TNS



THPZ2610TNS

TABLE À PIZZA AVEC GRANIT NOIR

REFRIGERATED PIZZA TABLE WITH BLACK GRANITE

Comptoir avec granit noir / Black granite countertop



Code / Article	THP2600TNS	THP3600TNS	THP2610TNS
Ext. L x P x H (mm)	1510x800x1000	2025x800x1000	2025x800x1000
Int. L x P x H (mm)	1052x630x589	1562x630x589	1562x630x589
Capacité / Capacity (L)	390(L)/145(L)	580(L)/307(L)	580(L)/307(L)
Température / Temperature	-2 + 8 (°C)	-2 + 8 (°C)	-2 + 8 (°C)
Énergétique / Energy Class	B	C	C
Evaporation	Ventilée / Fan	Ventilée / Fan	Ventilée / Fan
Consommation d'énergie / Power	2,53 (kW/24H)	3,59 (kW/24H)	2,53 (kW/24H)
Tension / Voltage	230 / 50 (V/Hz)	230 / 50 (V/Hz)	230 / 50 (V/Hz)
Option	THV1500/330-380	THV2000/330-380	THV2000/330-380
Prix / Price	2699 €	3099 €	3399 €

ACCESSOIRES (À MONTER SOI-MÊME) / ACCESSORY



Code / Article

Grille – PZ / Shelf

Glissière (Paire) – PZ / Guide (pair)

Wheelcabinet set 4

Pied / Feet / unité

Joint / Seal

Veuillez nous consulter pour les tarifs

VITRINES RÉFRIGÉRÉES

REFRIGERATED DISPLAY

- Gaz écologique R290 / Green Gas R290
- Intérieur et extérieur en acier inoxydable / Interior exterior stainless steel
- Réfrigération statique / Static cooling system
- Thermostat à affichage digital, Dixell ou Eliwell / Digital controller Eliwell ou Dixell
- Compartiments GN, Bacs GN non inclus / GN compartments, GN pans not included
- Avec vitre plate ou couvercle en inox / With flat glass or SS cover
- Nettoyage facile / Easy cleaning



THV



THVD

THV
THVD 330 GN 1/4

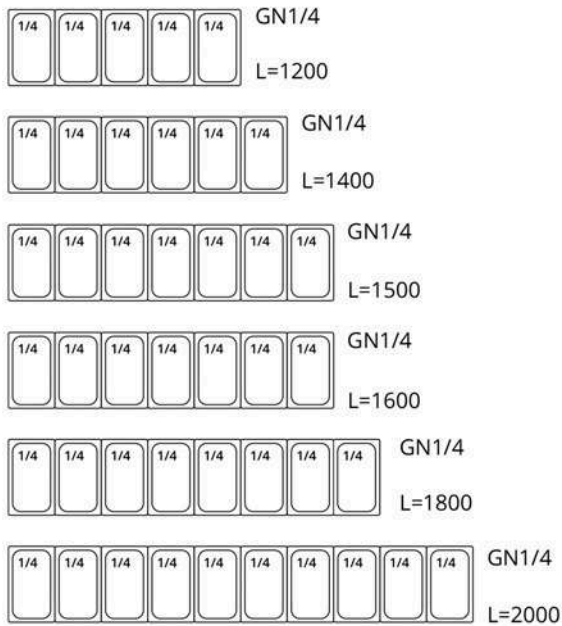

THV
THVD 380 GN 1/3

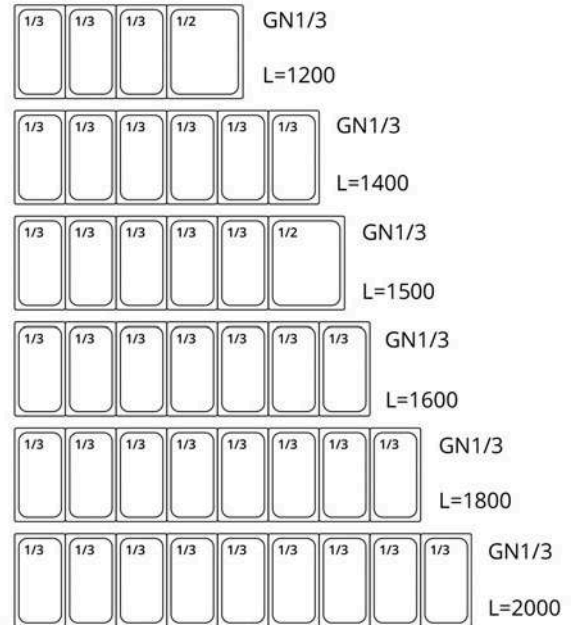

VITRINES RÉFRIGÉRÉES

REFRIGERATED DISPLAY

©AVEC VITRINES / WITH GLASS

Code / Article	THV1200/330	THV1400/330	THV1500/330	THV1600/330	THV1800/330	THV2000/330
LxPxH (mm)	1200 x 335 x 435	1400 x 335 x 435	1500 x 335 x 435	1600 x 335 x 435	1800 x 335 x 435	2000 x 335 x 435
Temp. (°C)	-2 +8	-2 +8	-2 +8	-2 +8	-2 +8	-2 +8
GN (1/4)	5	6	7	7	8	10
Evaporator	Stat.	Stat.	Stat.	Stat.	Stat.	Stat.
Puissance /Power (W)	149	149	149	149	149	149
Tension / Voltage (V/Hz)	230/50	230/50	230/50	230/50	230/50	230/50
Prix / Price	629 €	679 €	729 €	769 €	819 €	969 €

Code / Article	THV1200/380	THV1400/380	THV1500/380	THV1600/380	THV1800/380	THV2000/380
LxPxH (mm)	1200 x 395 x 435	1400 x 395 x 435	1500 x 395 x 435	1600 x 395 x 435	1800 x 395 x 435	2000 x 395 x 435
Temp. (°C)	-2 +8	-2 +8	-2 +8	-2 +8	-2 +8	-2 +8
GN (1/3)	4	6	6	7	8	9
Evaporator	Stat.	Stat.	Stat.	Stat.	Stat.	Stat.
Puissance /Power (W)	149	149	149	149	149	149
Tension / Voltage (V/Hz)	230/50	230/50	230/50	230/50	230/50	230/50
Prix / Price	669 €	709 €	749 €	789 €	849 €	989 €

©Avec couvercle en acier inoxydable / With Stainless Steel cover

Code / Article	THVD1200/330	THVD1400/330	THVD1500/330	THVD1600/330	THVD1800/330	THVD2000/330
LxPxH (mm)	1200 x 335 x 255	1400 x 335 x 255	1500 x 335 x 255	1600 x 335 x 255	1800 x 335 x 255	2000 x 335 x 255
Temp. (°C)	-2 +8	-2 +8	-2 +8	-2 +8	-2 +8	-2 +8
GN (1/4)	5	6	7	7	8	10
Evaporator	Stat.	Stat.	Stat.	Stat.	Stat.	Stat.
Puissance /Power (W)	149	149	149	149	149	149
Tension / Voltage (V/Hz)	230/50	230/50	230/50	230/50	230/50	230/50
Prix / Price	559 €	619 €	689 €	699 €	759 €	799 €

Code / Article	THVD1200/380	THVD1400/380	THVD1500/380	THVD1600/380	THVD1800/380	THVD2000/380
LxPxH (mm)	1200 x 395 x 255	1400 x 395 x 255	1500 x 395 x 255	1600 x 395 x 255	1800 x 395 x 255	2000 x 395 x 255
Temp. (°C)	-2 +8	-2 +8	-2 +8	-2 +8	-2 +8	-2 +8
GN (1/3)	4	6	6	7	8	9
Evaporator	Stat.	Stat.	Stat.	Stat.	Stat.	Stat.
Puissance /Power (W)	149	149	149	149	149	149
Tension / Voltage (V/Hz)	230/50	230/50	230/50	230/50	230/50	230/50
Prix / Price	599 €	639 €	699 €	739 €	779 €	819 €

© Dimensions THV2000/380

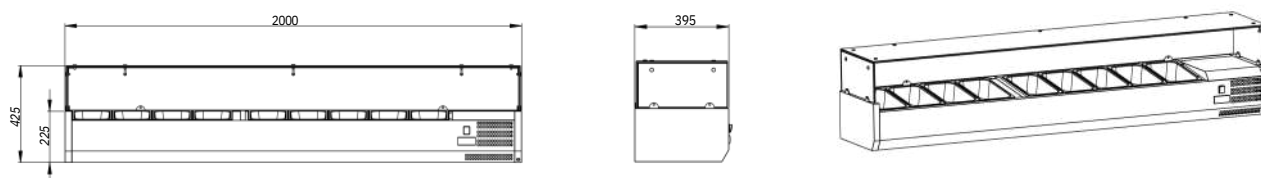

※Photos contractuelles et sous réserve du produit réel Contractual photos and subject to the actual product

MEUBLES RÉFRIGÉRÉS 700

REFRIGERATED COUNTERS 700

-Gaz écologique R290 / Green Gas R290 -Intérieur et extérieur en acier inoxydable (Paroi arrière galvanisée) / Interior exterior stainless steel (Galvanized rear wall) - Réfrigération ventilée / Ventilated cooling system - Thermostat à affichage digital, Dixell ou Eliwell / Digital controller Eliwell ou Dixell

-Isolation sans CFC épaisseur 60mm / Insulation thickness 60mm

-Fermeture automatique des portes / Self closing door

-Joint de porte lavable et remplaçable / Washable and replaceable door seals

-Classe climatique 4 / Climate classe 4

-Monté sur roues (en pieds possible) / With wheels (feets possible)

-Nettoyage facile / Esay cleaning

-1 grille par porte (530x325mm) / 1 shelf per door (530x325mm)



Fermeture automatique
Self closing



Avec les roues
With wheels



Affichage digital
Digital controller



Compresseur de marques
Brands compressor



Joint remplaçable
Replaceable door seal

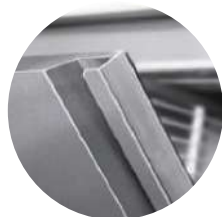

MEUBLES RÉFRIGÉRÉS 700

REFRIGERATED COUNTERS 700



THP2100TN/BT



THP3100TN/BT



THP4100TN/BT

©Sans dossier – Positif—Without backsplash - Positive

Code / Article	THP2100TN	THP3100TN	THP4100TN
LxPxH (mm)	1360 x 700 x 860	1795 x 700 x 860	2230 x 700 x 860
Capacité / Capacity (L)	260 (L) 200 (L)	417 (L) 307 (L)	550 (L) 413 (L)
Température / Temperature	- 2 + 8 (°C)	- 2 + 8 (°C)	- 2 + 8 (°C)
Énergétique / Energy Class	B	B	B
Consommation d'énergie / Power	1,97 (kW/24h)	2,97 (kW/24h)	4,46 (kW/24h)
Tension / Voltage (V/Hz)	230 / 50 (V/Hz)	230 / 50 (V/Hz)	230 / 50 (V/Hz)
Prix / Price	1699 €	1999 €	2499 €

©Sans dossier – Négatif—Without backsplash - Negative

Code / Article	THP2100BT	THP3100BT	THP4100BT
LxPxH (mm)	1360 x 700 x 860	1795 x 700 x 860	2230 x 700 x 860
Capacité / Capacity (L)	260 (L) 200 (L)	417 (L) 307 (L)	550 (L) 413 (L)
Température / Temperature	- 18 -22 (°C)	- 18 -22 (°C)	- 18 -22 (°C)
Énergétique / Energy Class	D	D	E
Consommation d'énergie / Power	6.7 (kW/24h)	8.5 (kW/24h)	11 (kW/24h)
Tension / Voltage (V/Hz)	230 / 50 (V/Hz)	230 / 50 (V/Hz)	2230 / 50 (V/Hz)
Prix / Price	1899 €	2299 €	2699 €

MEUBLES RÉFRIGÉRÉS 700

REFRIGERATED COUNTERS 700



THP2200TN



THP3200TN



THP4200TN

©Avec dossieret With backsplash

Code / Article	THP2200TN	THP3200TN	THP4200TN
LxPxH (mm)	1360 x 700 x 860+100	1795 x 700 x 860+100	2230 x 700 x 860+100
Capacité / Capacity (L)	260 (L) 200 (L)	417 (L) 307 (L)	550 (L) 413 (L)
Température / Temperature	- 2 + 8 (°C)	- 2 + 8 (°C)	- 2 + 8 (°C)
Énergétique / Energy Class	B	B	B
Consommation d'énergie / Power	1,97 (kW/24h)	2,97 (kW/24h)	4,46 (kW/24h)
Tension / Voltage (V/Hz)	230 / 50 (V/Hz)	230 / 50 (V/Hz)	230 / 50 (V/Hz)
Prix / Price	1799 €	2099 €	2599 €

©ACCESSOIRES ACCESSORY



Code / Article

Grille – 700 / Shelf - 700

Glissière (paire) – 700 / Guide (pair) - 700

Wheelcabinet 4

Pied / Feet / unité

Joint / Gasket -700

[Veuillez nous consulter pour les tarifs](#)

MEUBLES RÉFRIGÉRÉS 700 (Tiroirs)

REFRIGERATED COUNTERS 700 (Drawers)

- Gaz écologique R290 / Green Gas R290 - Intérieur et extérieur en acier inoxydable (Paroi arrière galvanisée) / Interior exterior stainless steel (Galvanized rear wall) - Réfrigération ventilée / Ventilated cooling system - Thermostat à affichage digital, Dixell ou Eliwell / Digital controller Eliwell ou Dixell

- Isolation sans CFC épaisseur 60mm / Insulation thickness 60mm - Classe climatique 4 / Climate class 4 - Monté sur roues (en pieds possible) / With wheels (feets possible) - Nettoyage facile / Easy cleaning - Assemblé avec tiroirs / Assembled with drawers - Dimensions tiroir GN 1/1 (Profondeur max 200mm, Bac GN non inclus) / Drawer dimensions GN1/1 (Depth max 200mm, GN Pan not included)



Fermeture automatique
Self closing



Avec les roues
With wheels



Affichage digital
Digital controller



Compresseur de marques
Brands compressor



Joint remplaçable
Replaceable door seal

MEUBLES RÉFRIGÉRÉS 700 (Tiroirs)

REFRIGERATED COUNTERS 700 (Drawers)



Code / Article	THP2100TN4D
LxPxH (mm)	1360 x 700 x 860
Consommation d'énergie / Power	1,97KW /24H
Température / Temperature	-2 + 8 °C
Tiroirs / Drawers	4
Prix / Price	2199 €



Code / Article	THP3100TN6D
LxPxH (mm)	1795 x 700 x 860
Consommation d'énergie / Power	2,97KW/24H
Température / Temperature	-2 + 8 °C
Tiroirs / Drawers	6
Prix / Price	2699 €



Code / Article	THP4100TN6D
LxPxH (mm)	2230 x 700 x 860
Consommation d'énergie / Power	4,5KW/24H
Température / Temperature	-2 + 8 °C
Tiroirs / Drawers	8
Prix / Price	3299 €

MEUBLES RÉFRIGÉRÉS 600

REFRIGERATED COUNTERS 600

- Gaz écologique R290 / Green Gas R290 - Intérieur et extérieur en acier inoxydable (Paroi arrière galvanisée) / Interior exterior stainless steel (Galvanized rear wall) - Réfrigération ventilée / Ventilated cooling system - Thermostat à affichage digital, Dixell ou Eliwell / Digital controller Eliwell ou Dixell

- Isolation sans CFC épaisseur 60mm / Insulation thickness 60mm
 - Fermeture automatique des portes / Self closing door
 - Joint de porte lavable et remplaçable / Washable and replaceable door seals
 - Classe climatique 4 / Climate class 4
 - Monté sur roues (en pieds possible) / With wheels (fe possible)
 - Nettoyage facile / Esay cleaning
 - 1 grille par porte (430x330) / 1 shelf per door (430x330)

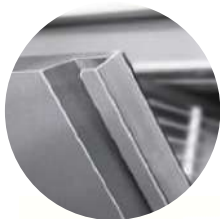

BT



Fermeture automatique
Self closing



Avec les roues
With wheels



Affichage digital
Digital controller



Compresseur de marques
Brands compressor



Joint remplaçable
Replaceable door seal

MEUBLES RÉFRIGÉRÉS 600

REFRIGERATED COUNTERS 600



THSNACK2100TN/BT



THSNACK3100TN/BT



THSNACK4100TN/BT

©Sans dossier – Positif—Without backsplash - Positive

Code / Article	THSNACK2100TN	THSNACK3100TN	THSNACK4100TN
LxPxH (mm)	1360 x 600 x 860	1795 x 600 x 860	2230 x 600 x 860
Capacité / Capacity (L)	260 (L) 200 (L)	417 (L) 307 (L)	550 (L) 413 (L)
Température / Temperature	-2 + 8 (°C)	-2 + 8 (°C)	-2 + 8 (°C)
Énergétique / Energy Class	B	B	B
Consommation d'énergie / Power	1,97 (kW/24h)	2,97 (kW/24h)	4,46 (kW/24h)
Tension / Voltage (V/Hz)	230 / 50 (V/Hz)	230 / 50 (V/Hz)	230 / 50 (V/Hz)
Prix / Price	1599 €	1899 €	2399 €

©Sans dossier – Négatif—Without backsplash - Negative

Code / Article	THSNACK2100BT	THSNACK3100BT	THSNACK4100BT
LxPxH (mm)	1360 x 600 x 860	1795 x 600 x 860	2230 x 600 x 860
Capacité / Capacity (L)	260 (L) 200 (L)	417 (L) 307 (L)	550 (L) 413 (L)
Température / Temperature	-18 -22 (°C)	-18 -22 (°C)	-18 -22 (°C)
Énergétique / Energy Class	D	E	E
Consommation d'énergie / Power	6.7 (kW/24h)	8.5 (kW/24h)	11(kW/24h)
Tension / Voltage (V/Hz)	230 / 50 (V/Hz)	230 / 50 (V/Hz)	230 / 50 (V/Hz)
Prix / Price	1899 €	2299 €	2699 €

MEUBLES RÉFRIGÉRÉS 600

REFRIGERATED COUNTERS 600



THSNACK2200TN



THSNACK3200TN



THSNACK4200TN

☉ Avec dossier / With backsplash

Code / Article	THSNACK2200TN	THSNACK3200TN	THSNACK4200TN
LxPxH (mm)	1360 x 600 x 860+100	1795 x 600 x 860+100	2230 x 600 x 860+100
Capacité / Capacity (L)	260 (L) 200 (L)	417 (L) 307 (L)	550 (L) 413 (L)
Température / Temperature	-2 + 8 (°C)	-2 + 8 (°C)	-2 + 8 (°C)
Énergétique / Energy Class	B	B	B
Consommation d'énergie / Power	1,97 (kW/24h)	2,97 (kW/24h)	4,46 (kW/24h)
Tension / Voltage (V/Hz)	230 / 50 (V/Hz)	230 / 50 (V/Hz)	230 / 50 (V/Hz)
Prix / Price	1699 €	1999 €	2499 €

☉ ACCESSOIRES ACCESSORY



Code / Article

Grille – / Shelf - SNACK

Glissière (paire) – / Guide (pair) - SNACK

Joint / Gasket -600

[Veuillez nous consulter pour les tarifs](#)

MEUBLES RÉFRIGÉRÉS 800

REFRIGERATED COUNTERS 800

- Gaz écologique R290 / Green Gas R290 - Intérieur et extérieur en acier inoxydable (Paroi arrière galvanisée) / Interior exterior stainless steel (Galvanized rear wall) - Réfrigération ventilée / Ventilated cooling system - Thermostat à affichage digital, Dixell ou Eliwell / Digital controller Eliwell ou Dixell

- Isolation sans CFC épaisseur 60mm / Insulation thickness 60mm
 - Fermeture automatique des portes / Self closing door
 - Joint de porte lavable et remplaçable / Washable and replaceable door seals
 - Classe climatique 4 / Climate class 4
 - Monté sur roues (en pieds possible) / With wheels (feets possible)
 - Nettoyage facile / Esay cleaning
 - 1 grille par porte (600x400) / 1 shelf per door (600x400)



Fermeture automatique
Self closing



Avec les roues
With wheels



Affichage digital
Digital controller



Compresseur de marques
Brands compressor



Joint remplaçable
Replaceable door seal

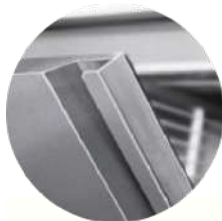

MEUBLES RÉFRIGÉRÉS 800

REFRIGERATED COUNTERS 800



THPA2100TN

Code / Article	THPA2100TN
LxPxH (mm)	1510 x 800 x 860
Capacité / Capacity (L)	260L
Température / Temperature	-2 + 8 (°C)
Énergétique / Energy Class	B
Consommation d'énergie / Power	1,97 (kW/24h)
Tension / Voltage (V/Hz)	230 / 50 (V/Hz)
Prix / Price	2099 €



THPA3100TN

Code / Article	THPA3100TN
LxPxH (mm)	2020 x 800 x 860
Capacité / Capacity (L)	417L
Température / Temperature	-2 + 8 (°C)
Énergétique / Energy Class	C
Consommation d'énergie / Power	2,97 (kW/24h)
Tension / Voltage (V/Hz)	230 / 50 (V/Hz)
Prix / Price	2399 €



THPA4100TN

Code / Article	THPA4100TN
LxPxH (mm)	2525 x 800 x 860
Capacité / Capacity (L)	770L
Température / Temperature	-2 + 8 (°C)
Énergétique / Energy Class	C
Consommation d'énergie / Power	3,9 (kW/24h)
Tension / Voltage (V/Hz)	230 / 50 (V/Hz)
Prix / Price	2799€

MEUBLES RÉFRIGÉRÉS 800

REFRIGERATED COUNTERS 800



THPA2200TN



THPA3200TN

©Avec dosseret With backslash

Code / Article	THPA2200TN	THPA3200TN
LxPxH (mm)	1510 x 800 x 860+100	2020 x 800 x 860+100
Capacité / Capacity (L)	260 (L) 200 (L)	417 (L) 307 (L)
Température / Temperature	-2 + 8 (°C)	-2 + 8 (°C)
Énergétique / Energy Class	B	C
Consommation d'énergie / Power	1,97 (kW/24h)	2,97 (kW/24h)
Tension / Voltage (V/Hz)	230 / 50 (V/Hz)	230 / 50 (V/Hz)
Prix / Price	2199 €	2499 €

©ACCESSOIRES ACCESSORY



Code / Article

Grille – 800 / Shelf - 800

Glissière (paire) – 800 / Guide (pair) - 800

Wheelcabinet 4

Pied / Feet / unité

Joint / Gasket -800

[Veuillez nous consulter pour les tarifs](#)

SALADETTES SNACK LINE

SALAD COUNTERS

- Gaz écologique R290 / Green Gas R290
- Intérieur et extérieur en acier inoxydable (Paroi arrière boisé) / Interior exterior stainless steel (Wood rear wall)
- Thermostat à affichage digital, Dixell ou Eliwell / Digital controller Eliwell ou Dixell
- Isolation sans CFC épaisseur 50mm / Insulation thickness 50mm
- Fermeture de porte automatique / Self closing door
- Classe climatique / Climate class 4
- Montée sur roues / With wheels
- Joint de porte lavable et remplaçable / Gasket washable and replaceable
- BAC GN non compris / GN-pan not included



Votre comptoir de service configurable individuellement avec des modules froids, chauds et neutres. Idéal pour tout, du petit bistrot au snack-bar rapide, en passant par les services de restauration collective. Personnalisez votre module en choisissant parmi une variété de couleurs de granit, différents décors et structures en verre pour créer une solution parfaitement adaptée à vos besoins.

Your individually configurable serving counter with cold, hot, and neutral modules. Perfect for every restaurant, from small bistros to fast food outlets and meal distribution in communal catering. Customize your module by choosing from a variety of granite colors, different decors, and glass structures to create a solution perfectly tailored to your needs.

SALADETTES SNACK LINE

SALAD COUNTERS



verre inclus
1430 x 590 x 496mm

Code / Article	THSAI158RG
Bac GN (non inclus)	4 x GN 1/1
Ext. L x P x H	1530 x 820 x 855 + verre (mm)
Int. L x P x H	970 620 x 700 (mm)
Capacité / Capacity (L)	502 (L)
Température / Temperature	0 + 8 (°C)
Evaporation	Ventilée / Fan
Consommation d'énergie / Power	2,5 (kW/24H)
Tension / Voltage (V/Hz)	230 / 50 (V/Hz)
Prix / Price	2609 €



verre inclus
1780 x 590 x 496mm

Code / Article	THSAI188RG
Bac GN (non inclus)	5 x GN 1/1
Ext. L x P x H	1880 x 820 x 855 + verre (mm)
Int. L x P x H	1240 x 620 x 700 (mm)
Capacité / Capacity (L)	612 (L)
Température / Temperature	0 + 8 (°C)
Evaporation	Ventilée / Fan
Consommation d'énergie / Power	6,72 (kW/24H)
Tension / Voltage (V/Hz)	230 / 50 (V/Hz)
Prix / Price	3179 €



verre inclus

Code / Article	THSAI228RG
Bac GN (non inclus)	6 x GN 1/1
Ext. L x P x H	2230 x 820 x 855 + verre (mm)
Int. L x P x H	1690 x 620 x 700 (mm)
Capacité / Capacity (L)	802 (L)
Température / Temperature	0 + 8 (°C)
Evaporation	Ventilée / Fan
Consommation d'énergie / Power	7,2 (kW/24H)
Tension / Voltage (V/Hz)	230 / 50 (V/Hz)
Prix / Price	3599 €

SALADETTES SNACK LINE

SALAD COUNTERS



verre noir inclus
1430 x 600 x 396mm

Code / Article	THSAI158S
Bac GN (non inclus)	4 x GN 1/1
Ext. L x P x H	1530 x 820 x 855 + verre (mm)
Int. L x P x H	970 x 620 x 700 (mm)
Capacité / Capacity (L)	502 (L)
Température / Temperature	0 + 8 (°C)
Evaporation	Ventilée / Fan
Consommation d'énergie / Power	2,5 (kW/24H)
Tension / Voltage (V/Hz)	230 / 50 (V/Hz)
Prix / Price	3199 €



verre noir inclus
1780 x 600 x 396mm

Code / Article	THSAI188S
Bac GN (non inclus)	5 x GN 1/1
Ext. L x P x H	1880 x 820 x 855 + verre (mm)
Int. L x P x H	1240 x 620 x 700 (mm)
Capacité / Capacity (L)	612 (L)
Température / Temperature	0 + 8 (°C)
Evaporation	Ventilée / Fan
Consommation d'énergie / Power	6,72 (kW/24H)
Tension / Voltage (V/Hz)	230 / 50 (V/Hz)
Prix / Price	3699 €



verre noir inclus
2130 x 600 x 396mm

Code / Article	THSAI228S
Bac GN (non inclus)	6 x GN 1/1
Ext. L x P x H	2230 x 820 x 855 + verre (mm)
Int. L x P x H	1690 x 620 x 700 (mm)
Capacité / Capacity (L)	802 (L)
Température / Temperature	0 + 8 (°C)
Evaporation	Ventilée / Fan
Consommation d'énergie / Power	7,2 (kW/24H)
Tension / Voltage (V/Hz)	230 / 50 (V/Hz)
Prix / Price	3999 €

BAIN-MARIE SNACK LINE

WATER BATH

- intérieur/extérieur en acier inoxydable / stainless steel interior/exterior
- Bain-Marie avec chauffe-silicone / Bain-Marie with silicone heater
- Plage de température +30 ~ +85°C / Temperature range +30 ~ +85°C
- Roulettes montées, pieds sur demande / Castors mounted, feet on request
- Plateau adapté aux bacs 2x GN1/1 H=200mm / Tray suitable for 2x GN1/1 containers H=200mm
- Livraison sans bac GN / Delivery without GN container
- Granit : gris rose ou noir (au choix) / Granite: pink gray or black (your choice)
- Épaisseur de la dalle de granit = 30 mm / Thickness of granite slab = 30 mm



©Vitre droite / Straight glass

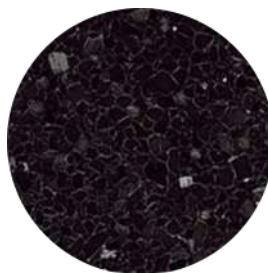

©Granit rose-gris / noir galaxy au choix



BAIN-MARIE SNACK LINE

WATER BATH



verre inclus
730 x 600 x 496mm

Code / Article	THBM88
Bac GN (non inclus)	2 x GN 1/1
L x P x H	830 x 820 x 855 + verre (mm)
Température / Temperature	30°C/85°C
Consommation	1 kw
Tension / Voltage (V/Hz)	230 / 50 (V/Hz)
Prix / Price	2099 €



verre inclus
1130 x 600 x 496mm

Code / Article	THBM128
Bac GN (non inclus)	3 x GN 1/1
L x P x H	1230 x 820 x 855 + verre (mm)
Température / Temperature	30°C/85°C
Consommation	2 kw
Tension / Voltage (V/Hz)	230 / 50 (V/Hz)
Prix / Price	2499 €



verre inclus
1430 x 600 x 496mm

Code / Article	THBM158
Bac GN (non inclus)	4 x GN 1/1
L x P x H	1530 x 820 x 855 + verre (mm)
Température / Temperature	30°C/85°C
Consommation	3 kw
Tension / Voltage (V/Hz)	230 / 50 (V/Hz)
Prix / Price	2899 €

BAIN-MARIE SNACK LINE

WATER BATH



verre noir inclus
730 x 600 x 396mm

Code / Article	THBM88S
Bac GN (non inclus)	2 x GN 1/1
L x P x H	830 x 820 x 855 + verre (mm)
Température / Temperature	30°C/85°C
Consommation	1 kw
Tension / Voltage (V/Hz)	230 / 50 (V/Hz)
Prix / Price	2399 €



verre noir inclus
1130 x 600 x 396mm

Code / Article	THBM128S
Bac GN (non inclus)	3 x GN 1/1
L x P x H	1230 x 820 x 855 + verre (mm)
Température / Temperature	30°C/85°C
Consommation	2 kw
Tension / Voltage (V/Hz)	230 / 50 (V/Hz)
Prix / Price	2899 €



verre noir inclus
1430 x 600 x 396mm

Code / Article	THBM158S
Bac GN (non inclus)	4 x GN 1/1
L x P x H	1530 x 820 x 855 + verre (mm)
Température / Temperature	30°C/85°C
Consommation	3 kw
Tension / Voltage (V/Hz)	230 / 50 (V/Hz)
Prix / Price	3299 €

CAISSES BOISÉS SNACK LINE

WOODED CHECKOUT TABLES

- Avec plan de travail en granit de 30mm / With 30mm granite worktop
- En acier inoxydable AISI 201 avec façade en bois / In AISI 201 stainless steel with wooden front
- Peut être combiné avec les saladettes / Can be combined with salads
- Tiroir fourni / Drawer provided
- Sous- structure ouverte / open substructure
- Pré-monté sur roulettes / Pre-assembled on casters



CAISSES BOISÉS SNACK LINE

WOODED CHECKOUT TABLES



Code / Article	THKT48	THKT68	THKT88
Dimension (mm)	400x820x855	600x820x855	800x820x855
Dim tiroirs (mm)	200x520x135	400x520x135	600x520x135
Prix (HT)	559 €	699 €	829 €



Code / Article	THKT48S	THKT68S	THKT88S
Dimension (mm)	400x820x855	600x820x855	800x820x855
Dim tiroirs (mm)	200x520x135	400x520x135	600x520x135
Prix (HT)	659 €	799 €	929 €

SALADETTES

SALAD COUNTERS

-Gaz écologique R290 / Green Gas R290 -Intérieur et extérieur en acier inoxydable (Paroi arrière galvanisée) / Interior exterior stainless steel (Galvanized rear wall) - Réfrigération statique / Static cooling system -Thermostat à affichage digital, Dixell ou Eliwell / Digital controller Eliwell ou Dixell

-Classe climatique 4 / Climate class 4 -Fermeture automatique des portes / Self closing door -Joint de porte lavable et remplaçable / Washable and replaceable door seals -Plan de travail en plastique / Plastic work top - Nettoyage facile / Easy cleaning -Compartiments GN (BACS non inclus) / Compartments (Pans not included) -1 grille par porte (323x560) / 1 shelf per door (323x560)



Serpentin en cuivre
Copper Oil



Fermeture automatique
Self closing



Affichage digital
Digital controller



Joint remplaçable
Replaceable door seal



THS900



SALADETTES

SALAD COUNTERS



THS900

Code / Article	THS900
L x P x H (mm)	900 x 700 x 870
Capacité / Capacity (L)	176 (L)
Température / Temperature	+2 + 8 (°C)
Evaporation	Statique / Static
Consommation d'énergie / Power	4,56 (kW/24H)
Tension / Voltage	230 / 50 (V/Hz)
Prix / Price	899 €



THS903

Code / Article	THS903
L x P x H (mm)	1365 x 700 x 870
Capacité / Capacity (L)	260 (L)
Température / Temperature	-2 +8 (°C)
Evaporation	Statique / Static
Consommation d'énergie / Power	9,6 (kW/24H)
Tension / Voltage	230 / 50 (V/Hz)
Prix / Price	1399 €



THS900CG



THS903CG

©Vitre bombée / Curved Glass

Code / Article	THS900CG	THS903CG
L x P x H (mm)	900 x 700 x 1330	1365 x 700 x 1330
Capacité / Capacity (L)	176 (L)	260 (L)
Température / Temperature	+2 +8 (°C)	+2 +8 (°C)
Evaporation	Statique / Static	Statique / Static
Consommation d'énergie / Power	4,56 (kW/24H)	9,6 (kW/24H)
Tension / Voltage	230 / 50 (V/Hz)	230 / 50 (V/Hz)
Prix / Price	1099 €	1599 €

SALADETTES

SALAD COUNTERS

-Gaz écologique R290 / Green Gas R290 -Intérieur et extérieur en acier inoxydable (Paroi arrière galvanisée) / Interior exterior stainless steel (Galvanized rear wall) - Réfrigération statique / Static cooling system -Thermostat à affichage digital, Dixell ou Eliwell / Digital controller Eliwell ou Dixell

-Classe climatique 4 / Climate class 4
 -Fermeture automatique des portes / Self closing door
 -Joint de porte lavable et remplaçable / Washable and replaceable door seals
 -Nettoyage facile / Easy cleaning
 -Compartiments GN (BACS non inclus) / Compartments (Pans not included)
 -1 grille par porte (323x560) / 1 shelf per door (323x560)
 -Bac GN non compris / GN Bac Not included



THS900VG

©Vitre droite / Plat Glass

Code / Article	THS900VG
L x P x H (mm)	900 x 700 x 1330
Capacité / Capacity (L)	176 (L)
Température / Temperature	+2 +8 (°C)
Evaporation	Statique / Static
Consommation d'énergie / Power	4,56 (kW/24H)
Tension / Voltage	230 / 50 (V/Hz)
Prix / Price	1099 €



THS903VG

©Vitre droite / Plat Glass

Code / Article	THS903VG
L x P x H (mm)	1365 x 700 x 1330
Capacité / Capacity (L)	260 (L)
Température / Temperature	+2 +8 (°C)
Evaporation	Statique / Static
Consommation d'énergie / Power	9,6 (kW/24H)
Tension / Voltage	230 / 50 (V/Hz)
Prix / Price	1599 €

SALADETTES

SALAD COUNTERS



THS901



THS903SSTOP

Code / Article	THS901	THS903 SSTOP
L x P x H (mm)	900 x 700 x 870	1365 x 700 x 870
Capacité / Capacity (L)	176 (L)	260 (L)
Température / Temperature	+2 + 8 (°C)	+2 + 8 (°C)
Evaporation	Statique / Static	Statique / Static
Consommation d'énergie / Power	2,60 (kW/24h)	4,52 (kW/24h)
Tension / Voltage	230 / 50 (V/Hz)	230 / 50 (V/Hz)
Prix / Price	999 €	1529 €

SALADETTES

SALAD COUNTERS



THPS900
GN1/6 x 5

Code / Article	THPS900
LxPxH (mm)	900 x 700 x 1080
Capacité / Capacity (L)	176 (L)
Température / Temperature	+2 + 8 (°C)
Evaporation	Statique / Static
Consommation d'énergie / Power	4,56 (kW/24H)
Tension / Voltage (V/Hz)	230 / 50 (V/Hz)
Prix / Price	1099 €



THPS903
GN1/6 x 8

Code / Article	THPS903
LxPxH (mm)	1365 x 700 x 1080
Capacité / Capacity (L)	368 (L)
Température / Temperature	+2 + 8 (°C)
Evaporation	Statique / Static
Consommation d'énergie / Power	9,6 (kW/24H)
Tension / Voltage (V/Hz)	230 / 50 (V/Hz)
Prix / Price	1599€



THPS900G
GN1/6 x 5

Code / Article	THPS900G
LxPxH (mm)	900 x 700 x 1080
Capacité / Capacity (L)	176 (L)
Température / Temperature	+2 + 8 (°C)
Evaporation	Statique / Static
Consommation d'énergie / Power	4,56 (kW/24H)
Tension / Voltage (V/Hz)	230 / 50 (V/Hz)
Prix / Price	1199 €



THPS903G
GN1/6 x 8

Code / Article	THPS903G
LxPxH (mm)	1365 x 700 x 1080
Capacité / Capacity (L)	260 (L)
Température / Temperature	+2 + 8 (°C)
Evaporation	Statique / Static
Consommation d'énergie / Power	9,6 (kW/24H)
Tension / Voltage (V/Hz)	230 / 50 (V/Hz)
Prix / Price	1699 €



SALADETTES SALAD COUNTERS

-Gaz écologique R290 / Green Gas R290 -Intérieur et extérieur en acier inoxydable (Paroi arrière galvanisée) / Interior exterior stainless steel (Galvanized rear wall) - Réfrigération statique / Static cooling system -Thermostat à affichage digital, Dixell ou Eliwell / Digital controller Eliwell ou Dixell

-Classe climatique 4 / Climate class 4
 -Fermeture automatique des portes / Self closing door
 -Joint de porte lavable et remplaçable / Washable and replaceable door seals
 -Nettoyage facile / Easy cleaning
 -Compartiments GN (BACS non inclus) / Compartments (Pans not included)
 -1 grille par porte (323x560) / 1 shelf per door (323x560)
 -Bac GN non compris / GN Bac Not included



Serpentin en cuivre
Copper Oil



Fermeture automatique
Self closing



Affichage digital
Digital controller



Compresseur de marques
Brands compressor



Joint remplaçable
Replaceable door seal



Option:THV1400/330



THS903PZ



Code / Article	THS903PZ
LxPxH (mm)	1400 x 700 x 1080
Capacité / Capacity (L)	368 (L)
Température / Temperature	+2 + 8 (°C)
Evaporation	Statique / Static
Consommation d'énergie / Power	400 (W)
Tension / Voltage (V/Hz)	230 / 50 (V/Hz)
Prix / Price	1599 €

SALADETTES

SALAD COUNTERS



THPS300
GN1/6 x 8



THPS200
GN1/6 x 5

SALADETTES

SALAD COUNTERS

Code / Article	THPS200	THPS300
L x P x H (mm)	900 x 700 x 950	1365 x 700 x 950
Capacité / Capacity (L)	176 (L)	260 (L)
Température / Temperature	+2 + 8 (°C)	+2 + 8 (°C)
Evaporation	Statique / Static	Statique / Static
Consommation d'énergie / Power	4,56 (kW/24H)	9,6 (kW/24H)
Tension / Voltage	230 / 50 (V/Hz)	230 / 50 (V/Hz)
Prix / Price	1099 €	1659 €

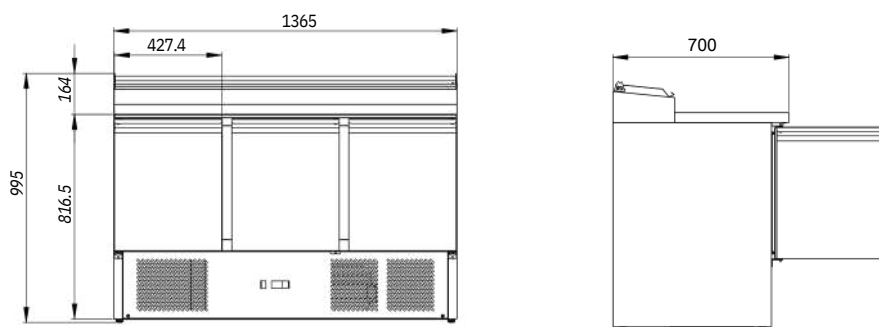

SALADETTES

SALAD COUNTERS

- Gaz écologique R290 / Green Gas R290 - Intérieur et extérieur en acier inoxydable (Paroi arrière galvanisée) / Interior exterior stainless steel (Galvanized rear wall) - Réfrigération ventilée / Ventilated cooling system - Thermostat à affichage digital, Dixell ou Eliwell / Digital controller Eliwell ou Dixell

- Isolation sans CFC épaisseur 60mm / Insulation thickness 60mm
 - Classe climatique 4 / Climate class 4
 - Fermeture automatique des portes / Self closing door
 - Joint de porte lavable et remplaçable / Washable and replaceable door seals
 - Nettoyage facile / Easy cleaning
 - Compartiments GN (BACS non inclus) / Compartments (Pans not included)



Serpentin en cuivre
Copper Oil



Fermeture automatique
Self closing



Affichage digital
Digital controller



Compresseur de marques
Brands compressor



Joint remplaçable
Replaceable door seal



THSH2000800



SALADETTES

SALAD COUNTERS



1 grille par porte / 1 shelf per door

Joint de porte lavable et remplaçable / Washable and replaceable door seals

Digital Thermostat

Code / Article	THSH2000/700	THSH3000/700
L x P x H (mm)	1360 x 700 x 1050	1795 x 700 x 1050
Bac GN / GN Pans	GN 1/4 x 7	GN 1/4 x 10
Température / Temperature	+2 + 8 (°C)	+2 + 8 (°C)
Evaporation	Ventilée / Fan	Ventilée / Fan
Consommation d'énergie / Power	6,96 (kW/24H)	9,6 (kW/24H)
Tension / Voltage	230 / 50 (V/Hz)	230 / 50 (V/Hz)
Prix / Price	2099 €	2599 €

Code / Article	THSH2000/800	THSH3000/800
L x P x H (mm)	1510 x 800 x 1050	2020 x 800 x 1050
Bac GN / GN Pans	GN 1/3 x 7	GN 1/3 x 10
Température / Temperature	+2 + 8 (°C)	+2 + 8 (°C)
Evaporation	Ventilée / Fan	Ventilée / Fan
Consommation d'énergie / Power	6,96 (kW/24H)	9,6 (kW/24H)
Tension / Voltage	230 / 50 (V/Hz)	230 / 50 (V/Hz)
Prix / Price	2499 €	2999 €

CELLULE DE REFROIDISSEMENT

COOLING CELL

- Gaz écologique R290 / Ecological gas R290
- Refroidissement statique ventilateur / Static cooling fan
- compresseur de marque / brand compressor
- Thermostat Dixelle / Dixelle Thermostat
- Isolation 60mm / 60mm insulation
- porte à fermeture automatique / self-closing door
- dégivrage automatique / automatic defrost
- Performance de refroidissement rapide : 9 kg de +65°C à +3°C en 90 minutes / Rapid cooling performance: 9 kg from +65°C to +3°C in 90 minutes
- Performance de surgélation : 6 kg de +65°C à -18°C en 240 minutes / Freezing performance: 6 kg from +65°C to -18°C in 240 minutes

- 3 emplacements pour GN2/3 H=65mm
3 slots for GN2/3 H=65mm

- Classe climatique 4 / Climate class 4

NEW



CELLULE DE REFROIDISSEMENT

COOLING CELL



Code / Article	TSD40
L x P x H (mm)	741 x 700 x 470 mm
Réfrigérant	R290
Production / 24H (Kg)	24
Stockage (Kg)	5
Volume (L) Tension /	9.4
Voltage Puissance (W)	220-240V
Thermostat Prix / Price	215
	Digital
	1299 €



Code / Article	TSD40B
L x P x H (mm)	741 x 700 x 470 mm
Réfrigérant	R290
Production / 24H (Kg)	45
Stockage (Kg)	9
Volume (L) Tension /	13.5
Voltage Puissance (W)	220-240V
Thermostat Prix / Price	300
	Digital
	1299 €

TABLES EN INOX

STAINLESS STEEL TABLES

- Construction en acier inoxydable AISI 201 / Stainless steel AISI 201
- Plan de travail renforcé et insonorisé / Reinforced shelf
- Pieds carrés ajustables / Adjustable square feet
- Facile à nettoyer / Easy to clean
- Livré démonté / Not assembled
- Auto assemblage facile / Easy self-assembly

Modèle sans dossieret / Model without backsplash



Code / Article	L x P x H (mm)	Prix / Price
THATS66	600 x 600 x 850	231€
THATS76	700 x 600 x 850	245 €
THATS86	800 x 600 x 850	259€
THATS106	1000 x 600 x 850	288€
THATS126	1200 x 600 x 850	303€
THATS146	1400 x 600 x 850	326€
THATS156	1500 x 600 x 850	345€
THATS166	1600 x 600 x 850	353€
THATS186	1800 x 600 x 850	378€
THATS206	2000 x 600 x 850	409€

Code / Article	L x P x H (mm)	Prix / Price
THATS67	600 x 700 x 850	239 €
THATS77	700 x 700 x 850	243€
THATS87	800 x 700 x 850	266€
THATS107	1000 x 700 x 850	292€
THATS127	1200 x 700 x 850	312€
THATS147	1400 x 700 x 850	341€
THATS157	1500 x 700 x 850	365€
THATS167	1600 x 700 x 850	368€
THATS187	1800 x 700 x 850	391€
THATS207	2000 x 700 x 850	439€



Modèle avec dossieret / Model withbacksplash



Code / Article	L x P x H (mm)	Prix / Price
THATS66A	600 x 600 x 850+100	252€
THATS76A	700 x 600 x 850+100	265€
THATS86A	800 x 600 x 850+100	279€
THATS106A	1000 x 600 x 850+100	303€
THATS126A	1200 x 600 x 850+100	331€
THATS146A	1400 x 600 x 850+100	358€
THATS156A	1500 x 600 x 850+100	376€
THATS166A	1600 x 600 x 850+100	388€
THATS186A	1800 x 600 x 850+100	418€
THATS206A	2000 x 600 x 850+100	449

Code / Article	L x P x H (mm)	Prix / Price
THATS67A	600 x 700 x 850+100	260€
THATS77A	700 x 700 x 850+100	272€
THATS87A	800 x 700 x 850+100	289€
THATS107A	1000 x 700 x 850+100	310€
THATS127A	1200 x 700 x 850+100	341€
THATS147A	1400 x 700 x 850+100	373€
THATS157A	1500 x 700 x 850+100	388€
THATS167A	1600 x 700 x 850+100	405€
THATS187A	1800 x 700 x 850+100	439€
THATS207A	2000 x 700 x 850+100	479€

TABLE D'ANGLE INOX

STAINLESS STEEL TABLE

- Construction en acier inoxydable AISI 201 / Stainless steel AISI 201
- Plan de travail renforcé et insonorisé/ Reinforced, soundproofed work surface
- Pieds carrés ajustables / Adjustable square feet
- Gain de place / Space-saving
- Livré démonté / Not assembled
- Version centrale et adossée / Central and back-to-back version



Code / Article	L x P x H (mm)	Prix / Price
THGESR106	1000 x 1000 x 600 x 850	359€
THGESR107	1000 x 1000 x 700 x 850	399€

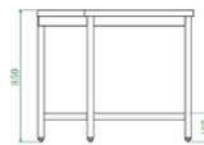
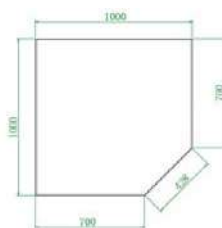

GESR107



Code / Article	L x P x H (mm)	Prix / Price
THGESR106A	1000 x 1000 x 600 x 850+100	389€
THGESR107A	1000 x 1000 x 700 x 850+100	419€

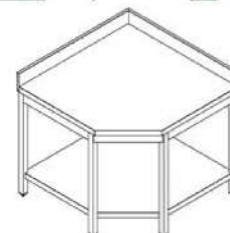
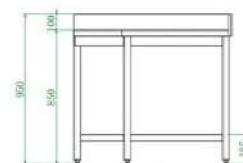
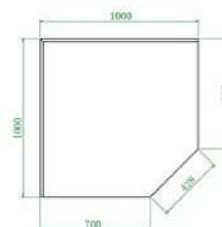

GESR107A

- Construction en acier inoxydable AISI 201 / Stainless steel AISI 201
- Facile à nettoyer / Easy to clean
- Livré démonté / Not assembled
- A monter uniquement sur les tables de travail THATS / Drawers only suitable for THATS worktable



Code / Article	L x P x H (mm)	Prix / Price
THMER46	400 x 560 x 555	229€
THMER47	400 x 660 x 555	249€



Code / Article	L x P x H (mm)	Prix / Price
THST1R46	400 x 560 x 140	149€
THST1R47	400 x 660 x 140	159€



Code / Article	L x P x H (mm)	Prix / Price
THST2R46	400 x 560 x 555	339€
THST2R47	400 x 660 x 555	359€



Code / Article	L x P x H (mm)	Prix / Price
THST3R46	400 x 560 x 555	379 €
THST3R47	400 x 660 x 555	399 €

TABLES DE BOUCHERIE (BILLOT)

BUTCHER TABLES

- Construction en acier inoxydable AISI 201 / Stainless steel AISI 201
- Plan de travail en polyéthylène blanc, épaisseur 25mm/ Worktop in white polyethylene
- Pieds carrés ajustables / Adjustable square feet
- Facile à nettoyer / Easy to clean
- Livré démonté / Not assembled
- Auto assemblage facile / Easy self-assembly



Code / Article	L x P x H (mm)	Prix / Price
THATS127C25	1200 x 700 x 850	550 €
THATS167C25	1600 x 700 x 850	690 €
THATS187C25	1800 x 700 x 850	750 €

ÉTAGÈRES DU CHEF

CHEF SHELVES

- Construction en acier inoxydable AISI 201 / Stainless steel AISI 201
- Pieds ajustables / Adjustable feet
- Facile à nettoyer / Easy to clean
- Livré démonté / Not assembled
- Auto assemblage facile / Easy self-assembly



*KBS non fourni /

Code / Article	L x P x H (mm)	Prix / Price
THAB1R084	800 x 350 x 400	57€
THAB1R104	1000 x 350 x 400	70€
THAB1R124	1200 x 350 x 400	89€
THAB1R144	1400 x 350 x 400	101€
THAB1R154	1500 x 350 x 400	106€
THAB1R164	1600 x 350 x 400	115€
THAB1R184	1800 x 350 x 400	128€
THAB1R204	2000 x 350 x 400	137€



*KBS non fourni /

Code / Article	L x P x H (mm)	Prix / Price
THAB2R087	800 x 350 x 700	97€
THAB2R107	1000 x 350 x 700	122€
THAB2R127	1200 x 350 x 700	149€
THAB2R147	1400 x 350 x 700	168€
THAB2R157	1500 x 350 x 700	185€
THAB2R167	1600 x 350 x 700	199€
THAB2R187	1800 x 350 x 700	219€
THAB2R207	2000 x 350 x 700	252€

RAMPES CHAUFFANTES

HEATED GANTRY

- Construction en acier inoxydable AISI 201 / Stainless steel AISI 201
- Interrupteur / Switch: ON/OFF
- 230V / 50Hz
- Éléments chauffants en céramique / Ceramic heating elements
- Auto assemblage facile / Easy self-assembly

*VIS DE MONTAGE NON FOURNIS / SCREW SETS NOT INCLUDED



Code / Article	L x P x H (mm)	Watt	Prix / Price
THKBS7 - 2	700 x 120 x 95	700	196 €
THKBS9 - 2	900 x 120 x 95	700	219 €
THKBS11 - 3	1100 x 120 x 95	1050	242 €
THKBS13 - 3	1300 x 120 x 95	1050	265 €
THKBS15 - 4	1500 x 120 x 95	1400	299 €
THKBS17 - 4	1700 x 120 x 95	1400	322 €
THKBS19 - 5	1900 x 120 x 95	1750	346 €

PLACARDS EN INOX

STAINLESS STEEL CABINET

- Construction en acier inoxydable AISI 201 / Stainless steel AISI 201
- Plan de travail renforcé / Reinforced shelf
- Avec l'étagère à l'intérieur / With the Shelf inside
- Portes coulissantes (Sauf L=600/800 modèle avec porte battante) / Sliding doors (Except L=600/800 with handle door)
- Pieds ajustables / Adjustable feet
- Facile à nettoyer / Easy to clean

Sans Dossieret / Without Backsplash



Code / Article	L x P x H (mm)	Prix / Price
THASR66	600 x 600 x 850	439€
THASR67	600 x 700 x 850	459€



Code / Article	L x P x H (mm)	Prix / Price
THASR86	800 x 600 x 850	499€
THASR87	800 x 700 x 850	559€



Code / Article	L x P x H (mm)	Prix / Price
THASR106	1000 x 600 x 850	619€
THASR126	1200 x 600 x 850	729€
THASR146	1400 x 600 x 850	799€
THASR156	1500 x 600 x 850	849€
THASR166	1600 x 600 x 850	889€
THASR186	1800 x 600 x 850	1009€
THASR206	2000 x 600 x 850	1099€
THASR107	1000 x 700 x 850	669€
THASR127	1200 x 700 x 850	799€
THASR147	1400 x 700 x 850	839€
THASR157	1500 x 700 x 850	879€
THASR167	1600 x 700 x 850	949€
THASR187	1800 x 700 x 850	1099€
THASR207	2000 x 700 x 850	1199€

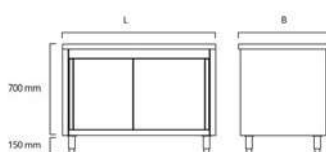

PLACARDS EN INOX

STAINLESS STEEL CABINET

- Construction en acier inoxydable AISI 201 / Stainless steel AISI 201
- Plan de travail renforcé / Reinforced shelf
- Avec l'étagère à l'intérieur / With the Shelf inside
- Portes coulissantes (Sauf L=600/800 modèle avec porte battante) / Sliding doors (Except L=600/800 with handle door)
- Pieds ajustables / Adjustable feet
- Facile à nettoyer / Easy to clean

Avec Dossieret / With Backsplash



Code / Article	L x P x H (mm)	Prix / Price
THASR66A	600 x 600 x 850+100	519€
THASR67A	600 x 700 x 850+100	529€



Code / Article	L x P x H (mm)	Prix / Price
THASR86A	800 x 600 x 850+100	579€
THASR87A	800 x 700 x 850+100	629€



Code / Article	L x P x H (mm)	Prix / Price
THASR106A	1000 x 600 x 850+100	679€
THASR126A	1200 x 600 x 850+100	799€
THASR146A	1400 x 600 x 850+100	869€
THASR156A	1500 x 600 x 850+100	899€
THASR166A	1600 x 600 x 850+100	949€
THASR186A	1800 x 600 x 850+100	1099€
THASR206A	2000 x 600 x 850+100	1199 €
THASR107A	1000 x 700 x 850+100	749€
THASR127A	1200 x 700 x 850+100	879€
THASR147A	1400 x 700 x 850+100	919€
THASR157A	1500 x 700 x 850+100	949€
THASR167A	1600 x 700 x 850+100	1099€
THASR187A	1800 x 700 x 850+100	1199 €
THASR207A	2000 x 700 x 850+100	1359€

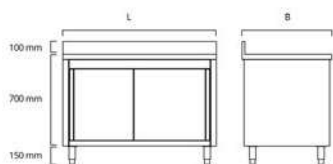

PLACARDS EN INOX

STAINLESS STEEL CABINET

- Construction en acier inoxydable AISI 201 / Stainless steel AISI 201
- Plan de travail renforcé / Reinforced shelf
- Porte battante / handle door
- Pieds ajustables / Adjustable feet
- Facile à nettoyer / Easy to clean



Sans Dossieret / Without Backsplash



Code / Article	L x P x H (mm)	Prix / Price
THESR106	1000 x 1000 x 850	999€
THESR107	1000 x 1000 x 850	1099€

Avec Dossieret / With Backsplash



Code / Article	L x P x H (mm)	Prix / Price
THESR106A	1000 x 1000 x 850+100	1099€
THESR107A	1000 x 1000 x 850+100	1199

€

PLACARDS EN INOX

STAINLESS STEEL CABINET

- Construction en acier inoxydable AISI 201 / Stainless steel AISI 201
- Plan de travail renforcé / Reinforced shelf
- Avec 3 tiroirs / With 3 Drawers
- Pieds ajustables / Adjustable feet
- Facile à nettoyer / Easy to clean

Sans Dossieret / Without Backsplash



Code / Article	L x P x H (mm)	Prix / Price
THSS3R56	500 x 600 x 850	799€
THSS3R57	500 x 700 x 850	899 €

Avec Dossieret / With Backsplash



Code / Article	L x P x H (mm)	Prix / Price
THSS3R56A	500 x 600 x 850+100	859 €
THSS3R57A	500 x 700 x 850+100	949 €

PLACARDS MURAUX EN INOX

STAINLESS STEEL WALL CABINET

- Construction en acier inoxydable AISI 201 / Stainless steel AISI 201
- Avec l'étagère à l'intérieur / With the Shel inside
- Portes coulissantes (Sauf L=600/800 modèle avec porte battante) / Sliding doors (Exept L=600/800 with handle door)
- Capacité de charge / Load capacity: 40kg Max



Code / Article	L x P x H (mm)	Prix / Price
THWSR64	600 x 400 x 650	299 €
THWSR84	800 x 400 x 650	339 €



Code / Article	L x P x H (mm)	Prix / Price
THWSR104	1000 x 400 x 650	399 €
THWSR124	1200 x 400 x 650	459 €
THWSR144	1400 x 400 x 650	489 €
THWSR154	1500 x 400 x 650	559 €
THWSR164	1600 x 400 x 650	589 €
THWSR184	1800 x 400 x 650	599 €
THWSR204	2000 x 400 x 650	699 €



Code / Article	L x P x H (mm)	Prix / Price
THEHR74	720 x 400 x 650	889 €



Artikel	L x P x H (mm)	Prix / Price
THWOR64	600 x 400 x 650	279€
THWOR84	800 x 400 x 650	319€
THWOR104	1000 x 400 x 650	379€
THWOR124	1200 x 400 x 650	439€
THWOR144	1400 x 400 x 650	459€
THWOR154	1500 x 400 x 650	529€
THWOR164	1600 x 400 x 650	549€
THWOR184	1800 x 400 x 650	579€
THWOR204	2000 x 400 x 650	639€

PLONGES EN INOX

STAINLESS STEEL SINK

- Dessus et bac de plonge en acier inoxydable / Top and bac Stainless steel: AISI 304
- Soubassement et pieds en acier inoxydable / Lower shelf and legs Stainless steel : AISI 201
- Bac et égouttoir insonorisé / Soundproof tank and plate rack
- Bord anti ruissellement, Egouttoir nervuré / antirunoff eddge Ribbed plate rack
- Dossier / Backsplash: 100mm
- Entretien facile / Easy maintenance
- Pieds réglables en hauteur / Adjustable feet
- Livré démonté sans siphon / Not assembled without siphon

Modèle avec passage lave-vaisselle / Model with dishwasher passage
Emplacement lave-vaisselle / Dishwasher Location : L=600mm



Code / Article	L x P x H (mm)	Bac L x P (mm)	Prix / Price
THSTR126SBL1	1200 x 600 x 850+100	400 x 400	599 €
THSTR127SBL1	1200 x 700 x 850+100	400 x 500	629 €
THSTR146SBL1	1400 x 600 x 850+100	500 x 400	659 €
THSTR147SBL1	1400 x 700 x 850+100	500 x 500	669€

*Egouttoir à droite, bac à gauche / Drainer right, sink left



Code / Article	L x P x H (mm)	Bac L x P (mm)	Prix / Price
THSTR126SBR1	1200 x 600 x 850+100	400 x 400	599 €
THSTR127SBR1	1200 x 700 x 850+100	400 x 500	629 €
THSTR146SBR1	1400 x 600 x 850+100	500 x 400	659 €
THSTR147SBR1	1400 x 700 x 850+100	500 x 500	669€

*Egouttoir à gauche, bac à droite / Drainer left, sink right



Modèle avec passage lave-vaisselle / Model with dishwasher passage
 Emplacement lave-vaisselle / Dishwasher Location : L=600mm



Code / Article	L x P x H (mm)	Bac L x P (mm)	Prix / Price
THSTR166SBL2	1600 x 600 x 850+100	400 x 400	719€
THSTR167SBL2	1600 x 700 x 850+100	400 x 500	779€
THSTR186SBL2	1800 x 600 x 850+100	500 x 400	859€
THSTR187SBL2	1800 x 700 x 850+100	500 x 500	959€

*Egouttoir à droite, bac à gauche / Drainer right, sink left



Code / Article	L x P x H (mm)	Bac L x P (mm)	Prix / Price
THSTR166SBR2	1600 x 600 x 850+100	400 x 400	719€
THSTR167SBR2	1600 x 700 x 850+100	400 x 500	779€
THSTR186SBR2	1800 x 600 x 850+100	500 x 400	859€
THSTR187SBR2	1800 x 700 x 850+100	500 x 500	959€

*Egouttoir à gauche, bac à droite / Drainer left, sink right

PLONGES EN INOX

STAINLESS STEEL SINK



Code / Article	L x P x H (mm)	Bac L x P (mm)	Prix / Price
THSTR106BL1	1000 x 600 x 850+100	400 x 400	499€
THSTR126BL1	1200 x 600 x 850+100	500 x 400	579€
THSTR107BL1	1000 x 700 x 850+100	400 x 500	549€
THSTR127BL1	1200 x 700 x 850+100	500 x 500	599€
THSTR147BL1	1400 x 700 x 850+100	600 x 500	639€

*Eguttoir à droite, bac à gauche / Drainer right, sink left



Code / Article	L x P x H (mm)	Bac L x P (mm)	Prix / Price
THSTR106BR1	1000 x 600 x 850+100	400 x 400	499€
THSTR126BR1	1200 x 600 x 850+100	500 x 400	579€
THSTR107BR1	1000 x 700 x 850+100	400 x 500	549€
THSTR127BR1	1200 x 700 x 850+100	500 x 500	599€
THSTR147BR1	1400 x 700 x 850+100	600 x 500	639€

*Eguttoir à gauche, bac à droite / Drainer left, sink right



Code / Article	L x P x H (mm)	Bac L x P (mm)	Prix / Price
THSTR146BL2	1400 x 600 x 850+100	400 x 400	679€
THSTR166BL2	1600 x 600 x 850+100	500 x 400	739€
THSTR186BL2	1800 x 600 x 850+100	500 x 400	869€
THSTR147BL2	1400 x 700 x 850+100	400 x 500	719€
THSTR167BL2	1600 x 700 x 850+100	400 x 500	799€
THSTR187BL2	1800 x 700 x 850+100	500 x 500	949€

*Eguttoir à droite, bac à gauche / Drainer right, sink left



Code / Article	L x P x H (mm)	Bac L x P (mm)	Prix / Price
THSTR146BR2	1400 x 600 x 850+100	400 x 400	679€
THSTR166BR2	1600 x 600 x 850+100	500 x 400	739€
THSTR186BR2	1800 x 600 x 850+100	500 x 400	869€
THSTR147BR2	1400 x 700 x 850+100	400 x 500	719€
THSTR167BR2	1600 x 700 x 850+100	400 x 500	799€
THSTR187BR2	1800 x 700 x 850+100	500 x 500	949€

*Eguttoir à gauche, bac à droite / Drainer left, sink right

PLONGES EN INOX

STAINLESS STEEL SINK



Code / Article	L x P x H (mm)	Bac L x P (mm)	Prix / Price
THSTR66BM1	600 x 600 x 850+100	400 x 400	399€
THSTR76BM1	700 x 600 x 850+100	500 x 400	429€
THSTR86BM1	800 x 600 x 850+100	500 x 400	459€
THSTR67BM1	600 x 700 x 850+100	400 x 500	429€
THSTR77BM1	700 x 700 x 850+100	500 x 500	459€
THSTR87BM1	800 x 700 x 850+100	600 x 500	469€
THSTR107BM1	1000 x 700 x 850+100	860 x 500	599€
THSTR127BM1	1200 x 700 x 850+100	1060 x 500	639€



Code / Article	L x P x H (mm)	Bac L x P (mm)	Prix / Price
THSTR106BM2	1000 x 600 x 850+100	400 x 400	599€
THSTR126BM2	1200 x 600 x 850+100	500 x 400	659€
THSTR146BM2	1400 x 600 x 850+100	500 x 400	699€
THSTR107BM2	1000 x 700 x 850+100	400 x 500	659€
THSTR127BM2	1200 x 700 x 850+100	500 x 500	699€
THSTR147BM2	1400 x 700 x 850+100	600 x 500	739€



Code / Article	L x P x H (mm)	Bac L x P (mm)	Prix / Price
THSTR206BM2	2000 x 600 x 850+100	500 x 400	899€
THSTR207BM2	2000 x 700 x 850+100	500 x 500	999€

LAVE MAINS INOX

STAINLESS STEEL HANDWASH SINK

- Lave mains en acier inoxydable / Stainless steel Handwash : AISI 201
- Lave mains avec robinet actionné avec une pédale/ Washbow with tap operated with a pedal



Code / Article	L x P x H (mm)	Prix / Price
THHWR43K	400 x 340 x 585	229 €

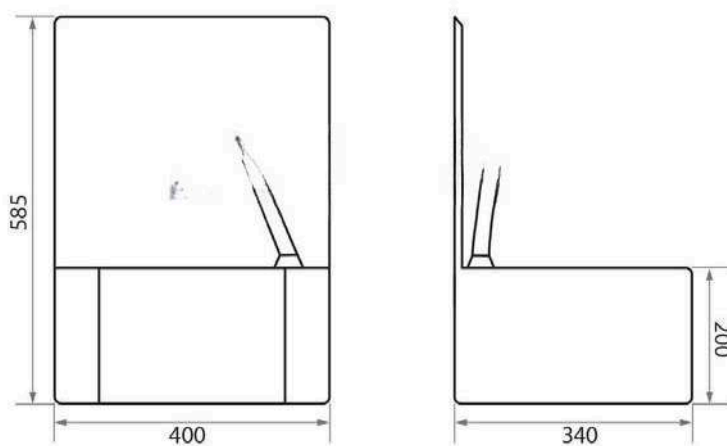

ÉTAGÈRES MURALES

STAINLESS STEEL WALL SHELVES

- Étagère en acier inoxydable / Stainless steel wall shelves: AISI 201
- Adjustable en hauteur / Height adjustable
- Capacité de charge par étagère / Load capacity per shelf: 25kg
- Vis de fixation non fourni / Fixing screws not included
- Livré démonté / Delivered not assembled

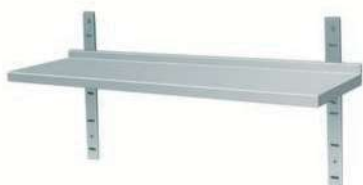

Code / Article	L x P x H (mm)	Prix / Price	Code / Article	L x P x H (mm)	Prix / Price
THWBS1R63	600 x 300 x 350	81€	THWBS1R64	600 x 400 x 350	93€
THWBS1R83	800 x 300 x 350	90€	THWBS1R84	800 x 400 x 350	103€
THWBS1R103	1000 x 300 x 350	99€	THWBS1R104	1000 x 400 x 350	111€
THWBS1R123	1200 x 300 x 350	103€	THWBS1R124	1200 x 400 x 350	119€
THWBS1R143	1400 x 300 x 350	117€	THWBS1R144	1400 x 400 x 350	133€
THWBS1R153	1500 x 300 x 350	122€	THWBS1R154	1500 x 400 x 350	145€
THWBS1R163	1600 x 300 x 350	125€	THWBS1R164	1600 x 400 x 350	155€
THWBS1R183	1800 x 300 x 350	135€	THWBS1R184	1800 x 400 x 350	164€
THWBS1R203	2000 x 300 x 350	148€	THWBS1R204	2000 x 400 x 350	176€



Code / Article	L x P x H (mm)	Prix / Price	Code / Article	L x P x H (mm)	Prix / Price
THWBS2R63	600 x 300 x 700	125€	THWBS2R64	600 x 400 x 700	135€
THWBS2R83	800 x 300 x 700	137€	THWBS2R84	800 x 400 x 700	147€
THWBS2R103	1000 x 300 x 700	150€	THWBS2R104	1000 x 400 x 700	173€
THWBS2R123	1200 x 300 x 700	156€	THWBS2R124	1200 x 400 x 700	183€
THWBS2R143	1400 x 300 x 700	178€	THWBS2R144	1400 x 400 x 700	195€
THWBS2R153	1500 x 300 x 700	184€	THWBS2R154	1500 x 400 x 700	219€
THWBS2R163	1600 x 300 x 700	194€	THWBS2R164	1600 x 400 x 700	237€
THWBS2R183	1800 x 300 x 700	204€	THWBS2R184	1800 x 400 x 700	252€
THWBS2R203	2000 x 300 x 700	226€	THWBS2R204	2000 x 400 x 700	265€

ÉTAGÈRES MURALES

STAINLESS STEEL WALL SHELVES

-Etagère inox ajourée en forme de tubes inox. Profondeur 300mm, hauteur totale 250mm. Capacité de charge jusqu'à 30kg -Livrée démontée avec 2 ou 3 équerres de fixation selon la longueur -Construction tout inox AISI 201 - Fixations non fournies

-Openwork stainless steel shelf in the shape of stainless steel tubes. Depth 300mm, total height 250mm. Load capacity up to 30kg -Delivered disassembled with 2 or 3 fixing brackets depending on length -All AISI 201 stainless steel construction -Fixings not supplied



Code / Article	L x P x H (mm)	Prix / Price
THWGL103	1000 x 300 mm	109€
THWGL123	1200 x 300 mm	119€
THWGL143	1400 x 300 mm	129€
THWGL153	1500 x 300 mm	139€
THWGL163	1600 x 300 mm	149€
THWGL183	1800 x 300 mm	169€
THWGL203	2000 x 300 mm	179€

Etagère Micro-onde

Capacité 50kg
AISI 201: 1.0mm



Code / Article	L x P x H (mm)	Prix / Price
THWBS1R65	600 x 500 x 320 mm	169€

CHARIOTS

STAINLESS STEEL TROLLEY

- Chariot en acier inoxydable / Stainless steel trolley : AISI 201
- Avec les 4 roulettes / With 4 wheels
- Capacité de charge max / Load capacity max: 45kg
- Facile à nettoyer / Easy to clean
- Livré démonté / Delivered not assembled

Chariot à 2 niveaux / Trolley with 2 leves



Code / Article	L x P x H (mm)	Prix / Price
THS2R85	800 x 500 x 940	149€
THS2R105	1000 x 500 x 940	159€
THS2R106	1000 x 600 x 940	169€
THS2R126	1200 x 600 x 940	199€

Chariot à 3 niveaux / Trolley with 3 leves



Code / Article	L x P x H (mm)	Prix / Price
THS3R85	800 x 500 x 940	199€
THS3R105	1000 x 500 x 940	219€
THS3R106	1000 x 600 x 940	239€
THS3R126	1200 x 600 x 940	269€

POUBELLES

TRASH BIN

-Poubelle en acier inoxydable / Stainless steel trash bin: AISI 201
 -Idéal pour les fast-foods, cafés, restaurants self-service et cantines / Perfect for fast foods, cafes, self-service restaurants and canteens



Code / Article	φ x H (mm)	Liter (L)	Prix / Price
AD5903	380 x 630	60	149€
AD5904	450 x 630	80	189€
AD6904	450 x 730	95	219€



Code / Article	L x P x H (mm)	Liter (L)	Prix / Price
AER47	700 x 400 x 770	120	299 €



Code / Article	L x P x H (mm)	Prix / Price
AD6000	500 x 530 x 1200 (+25)	489 €

※ Poubelle plastique fournie / Plastic trash Included : 60L

RAYONNAGES INOX

STAINLESS STEEL SHELVING

- Structure en acier inoxydable / Stainless steel structure : AISI 201
- 4 étagères renforcées / reinforced shelves
- Ajustable en hauteur / Height adjustable
- Facile à nettoyer / Easy to clean
- Livré démonté / Delivered not assembled



Code / Article	L x P x H (mm)	Prix / Price
THSS640L	600 x 400 x 1800	299€
THSS840L	800 x 400 x 1800	329€
THSS1040L	1000 x 400 x 1800	379€
THSS1240L	1200 x 400 x 1800	409€
THSS1440L	1400 x 400 x 1800	459€
THSS1640L	1600 x 400 x 1800	489€
THSS1840L	1800 x 400 x 1800	549€
THSS2040L	2000 x 400 x 1800	569€



Code / Article	L x P x H (mm)	Prix / Price
THSS650L	600 x 500 x 1800	339€
THSS850L	800 x 500 x 1800	379€
THSS1050L	1000 x 500 x 1800	439€
THSS1250L	1200 x 500 x 1800	479€
THSS1450L	1400 x 500 x 1800	519€
THSS1650L	1600 x 500 x 1800	559€
THSS1850L	1800 x 500 x 1800	609€
THSS2050L	2000 x 500 x 1800	649€

ECHELLES INOX

STAINLESS STEEL LADDER

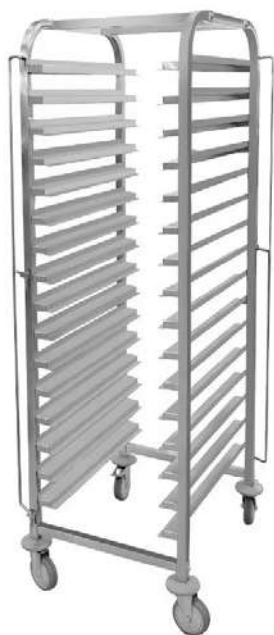

Code / Article	THTR18A
L x P x H (mm)	410 x 600 x 1785
Type	400 x 600 / GN 1/1
Niveau / Level	18
Prix / Price	399 €

- Structure en acier inoxydable / Stainless steel structure : AISI 201
- Roues / Wheels: 4 (Dont 2 avec freins / 2 brakes)
- Livré démonté / Delivered not assembled

SEPARATEUR DE GRAISSES

STAINLESS STEEL SEPARATOR



- Structure en acier inoxydable / Stainless steel structure : AISI 304
- Avec robinet de vidange / With the drain tap

Code / Article	Liter (L)	L x P x H (mm)	Prix / Price
THOW30	30	567 x 317 x 312	299 €
THOW60	60	647 x 376 x 400	359 €

GAUFRIER/MACHINE À PANINI

WAFFEL MAKER/PANINI MACHINE

- Structure en acier inoxydable de haute qualité / Stainless steel structure
- Plaque en fonte moulée type liégeois / Cast iron groove
- Thermostat et voyant / Thermostat and indicator light
- Interrupteur / Swith : ON / OFF



Code / Article	TH811EA
L x P x H	410 x 300 x 190 (mm)
Superieur / Top L x P	338 x 210 (mm)
Inférieur / Bottem L x P	358 x 220 (mm)
Température / Temperature	50 – 300°C
Puissance / Power	2,2 (kW)
Tension / Voltage	220 - 240 (V)
Prix / Price	339 €



Code / Article	TH813A
L x P x H	570 x 300 x 190 (mm)
Superieur / Top L x P	(215 x 215) mm x 2
Inférieur / Bottem L x P	500 x 220 (mm)
Température / Temperature	50 – 300°C
Puissance / Power	3,6 (kW)
Tension / Voltage	220 - 240 (V)
Prix / Price	519 €

TOASTER

TOASTER



Code / Article	THAR1
L x P x H	470 x 350 x 300 (mm)
Int L x P x H	358 x 245 x 185 (mm)
Grille / Shelf	346 x 236
Puissance / Power	2,04 / 2,4 (kW)
Tension / Voltage	220 - 240 (V)
Prix / Price	339 €



Code / Article	THAR2
L x P x H	470 x 350 x 415 (mm)
Int L x P x H	358 x 245 x 185 (mm)
Grille / Shelf	(346 x 236) x 2
Puissance / Power	3,06 / 3,6 (kW)
Tension / Voltage	220 - 240 (V)
Prix / Price	419 €

- Structure en acier inoxydable de haute qualité / Stainless steel structure
- Chauffage par tube / Tube heating
- Minuterie / Timer
- Thermostat EGO / EGO Thermostat

PLAQUE À SNACKER

GRIDDLE PLATE



Code / Article	THGH400	THGH550A	THGH610
L x P x H	400 x 550 x 270 (mm)	550 x 530 x 270 (mm)	610 x 550 x 270 (mm)
Puissance / Power	3 (kW)	3 (kW)	6 (kW)
Tension / Voltage	220 - 240 (V)	220 - 240 (V)	220 - 240 (V)
Prix / Price	459 €	499 €	599 €

- Structure en acier inoxydable de haute qualité / Stainless steel structure
- Plaque chromé / Chrome plate
- Thermostat EGO / EGO Thermostat
- Spatule incluse / Spatula included : 1

HACHOIR À VIANDE MEAT MINCER



Code / Article	THMM12	THMM22
L x P x H	475 x 225 x 365 (mm)	520 x 300 x 390 (mm)
Puissance / Power	850 (W)	1100 (W)
Production	120 (kg/h)	220 (kg/h)
Tension / Voltage	230 / 50 (V/Hz)	230 / 50 (V/Hz)
Prix / Price	669 €	799 €

- Structure en Aluminium anodisé / Aluminium anodized structure
- Couteau et lame inox / Stainless steel knife and blade
- 2 Disques Diamètre / 2 discs Diameter: 8mm - 5mm
- Interrupteur / Switch : ON / OFF

COUPES-LÉGUME VEGETABLE CUTTER



Code / Article	THVC300
L x P x H	622 x 247 x 507 (mm)
Puissance / Power	550 (W)
Tension / Voltage	230 / 50 (V/Hz)
Prix / Price	969 €

- Structure en Aluminium anodisé / Aluminium anodized structure
- Éjection frontale / Frontal ejection
- Interrupteur / Switch : ON / OFF

※Ne pas convenir au fromage
Not suitable for cheese

MARMITE À SOUPE

SOUP POT



Code / Article	THSK10
L x P x H	340 x 367 x 360 (mm)
Litre / Liter	10 (L)
Puissance / Power	400 (W)
Tension / Voltage	230 / 50 (V/Hz)
Prix / Price	169 €

- Structure en Aluminium anodisé / Aluminium anodized structure
- Thermostat et voyant / Thermostat and indicator light
- Interrupteur / Swith : ON / OFF

BAIN MARIE

WATER BATH



Code / Article	THTHBMT
L x P x H	577 x 340 x 240 (mm)
Robinet / Tap	Ja / Yes
Puissance / Power	400 (W)
Tension / Voltage	230 / 50 (V/Hz)
Prix / Price	229 €

- Structure en acier inoxydable de haute qualité / Stainless steel structure
- BAC GN1/1 (Profondeur / Depth: 150mm)
- Robinet / Tap
- Thermostat et voyant / Thermostat and indicator light
- Interrupteur / Swith : ON / OFF



FOURNEAUX À GAZ

GAS COOKER

- Structure en acier inoxydable / Stainless steel structure: AISI 304
- Dessus épaisseur / Top thickness: 1.2mm
- Brûleur et grille en fonte / Burners and cast iron grids
- Pieds réglables en hauteur / Adjustable feet
- Nettoyage facile / Easy cleaning



5.5

4.5

Code / Article	THG7F2PW 
L x P x H	400 x 700 x 900 (+140) (mm)
Brûleurs / Burners	5,5 + 4,5 (kW)
Gaz LPG / Gas	0,7 (kg/h)
Gaz NG / Gas	0,95 (m³/h)
Puissance / Power	10 (kW)
Prix / Price	1399 €



5.5

4.5

4.5

5.5

Code / Article	THG7F4PW 
L x P x H	800 x 700 x 900 (+140) (mm)
Brûleurs / Burners	2x 5,5 + 2x 4,5 (kW)
Gaz LPG / Gas	1,41 (kg/h)
Gaz NG / Gas	1,90 (m³/h)
Puissance / Power	20 (kW)
Prix / Price	2499 €

※Installation uniquement par un professionnel
Installation only by a professional

FOURNEAUX À GAZ

GAS COOKER

- Structure en Aluminium anodisé / Aluminium anodized structure
- Éjection frontale / Frontal ejection
- Interrupteur / Swith : ON / OFF



5.5	4.5
4.5	5.5

※Installation uniquement par un professionnel
Installation only by a professional

Code / Article	THG7F4PW-FG1 
L x P x H	800 x 700 x 900 (+140) (mm)
L x P x H (Four/Oven)	642 x 445 x 321 (mm)
Grille / Shelf	600 x 400 (mm)
BAC / PAN	GN 1/1
Bruleurs / Burners	2x 5,5 + 2x 4,5 (kW)
Puissance Four	4,8 (kW)
Gaz LPG	1,53 (kg/h)
Gaz NG	2,45 (m³/h)
Puissance	25,8 (kW)
Preis / Price	2999 €

RECHAUD WOK CHINESE WOK

- Fabrication en acier inoxydable / Stainless steel construction
- Pieds réglable en hauteur / Height adjustable feet
- Large Chêneaux de vidange à l'arrière pour l'évacuation rapide / Large drainage gutters at the rear for rapid evacuation
- puissance importante instantanée / significant instantaneous power
- Dossieret inox 280mm / Stainless steel backsplash 280mm
- Vanne de gaz sécurité avec veilleuse et thermocouple / Safety gas valve with pilot light and thermocouple

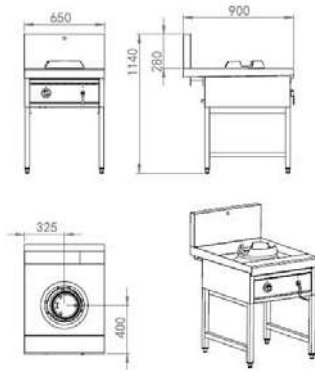

Code / Article	THW1 
L x P x H	650 x 900 x 860+280 (mm)
Puissance / Power	35 (kW)
LPG (kg/h) / NG (m3/h)	W:LPG (2.7Kg/h) NG (3.5m³/h)
Prix / Price	1599€

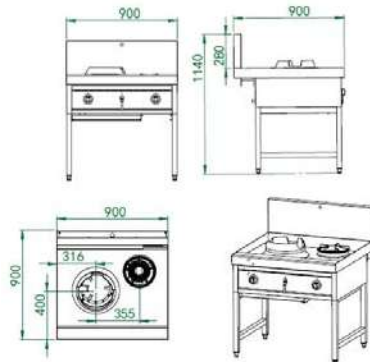

Code / Article	THW1+V1 
L x P x H	900 x 900 x 860+280 (mm)
Puissance / Power	35+8 (kW)
LPG (kg/h) / NG (m3/h)	W: LPG (2.7Kg/h) NG (3.5m³/h) V:LPG (0.62Kg/h) NG (0.8m³/h)
Prix / Price	2199€

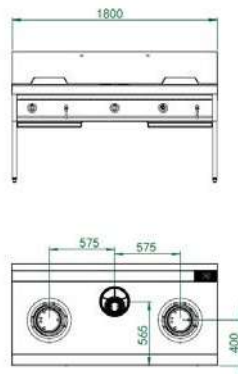

Code / Article	THW2+V1 
L x P x H	1800 x 900 x 860+280 (mm)
Puissance / Power	35 x 2+8 (kW)
LPG (kg/h) / NG (m3/h)	W: LPG (2.7Kg/h) x 2 NG (3.5m³/h) x 2 V:LPG (0.62Kg/h) NG (0.8m³/h)
Prix / Price	3599€



RECHAUD WOK CHINESE WOK



Code / Article	TH-WG9F2PW 
L x P x H	450 x 900 x 860+280 (mm)
Puissance / Power	7.5 x 2 (kW)
LPG (kg/h) / NG (m3/h)	LPG (0.58Kg/h) x 2 NG (0.75m³/h) x 2
Prix / Price	1399€



Code / Article	TH-WG9F4PW 
L x P x H	900 x 900 x 860+280 (mm)
Puissance / Power	7.5 x 4 (kW)
LPG (kg/h) / NG (m3/h)	LPG (0.58Kg/h) x 4 NG (0.75m³/h) x 4
Prix / Price	1899€

※Installation uniquement par un professionnel
Installation only by a professional

RÉCHAUD À GAZ

GAS STOVE

- Structure en acier inoxydable / Stainless steel structure
- Brûleur et grille en fonte / Burners and cast iron grids
- Thermocouple de sécurité / Flameout protection
- Pieds réglables en hauteur / Adjustable feet



Code / Article	THRB1B
L x P x H	455 x 522 x 430 (mm)
Puissance / Power	24 (kW)
LPG / Propangas	1,74 (kg/h)
NG / Erdgas	2,46 (m³/h)
Prix / Price	629 €